

P6-Series

P6-H106-02 / P6-H206-02 / P6-H306-02

1-2, 2, & 3 Person Saunas



OWNER'S MANUAL

INFRARED MODEL SAUNA

FOR INDOOR USE ONLY

120V/15AMP DEDICATED CIRCUIT REQUIRED for P6-H106-02 / P6-H206-02

120V/20AMP DEDICATED CIRCUIT REQUIRED for P6-H306-02

Carefully and thoroughly read this Owner's Manual before using/operating the sauna. We recommend keeping this Owner's Manual for regular review and future reference. Parts and accessories may vary and are subject to change.

TABLE OF CONTENTS

Packing List	2
Visual Assembly Diagram	6
Schematics	9
Schematic Layout	12
Dimensional Diagram	15
Screw Identification and Location Chart	18
Highlights	19
Assembly Instructions	22
Operating the Sauna	28
Tips for Using Your Sauna	30
Safety Instructions	31
Safeguards for Your Sauna	33
Troubleshooting Guide	33
Maintenance	35
Warranty	36
Warranty Card	39

WARNING: Visually inspect all heaters before assembly to make sure they are not damaged. Any excessive vibrations during transport could cause damage to the heating elements. DO NOT START the sauna if damage is detected! Contact your dealer or manufacturer for troubleshooting and replacement parts.

Packing List (main panels)

1pc Front Panel	1pc Rear Panel	1pc Left Side Panel
1pc Right Side Panel	1pc Roof Panel	1pc Roof Cover
1pc Bench	1pc Himalayan Salt Block Panel	1pc Floor Panel

NOTE: Your model sauna has been completely assembled and tested prior to packaging. The rear wall panel is intentionally warped as part of the overall design. Two adults will be needed to assemble the sauna room.

CAUTION: Exit Sauna Immediately If You Feel Dizzy, Sleepy, Or Any Discomfort.

What Are Infrared Rays?

Infrared is the band of light we perceive as heat. We cannot see this band of light with the naked eye, but we can feel this type of light in the form of heat. Our sun produces most of its energy output in the infrared segment of the spectrum. Infrared rays heat your body without having to heat the air in-between. This process is called conversion.

The infrared is divided into 3 segments by wavelengths measured in microns: Near Infrared – 0.76-1.5 microns; Middle Infrared – 1.5-5.6 microns; and Far Infrared – 5.6-1000 microns. Among these segments, Far Infrared penetrates organic substances such as the human body two to three inches so that the warming effect is very uniform.

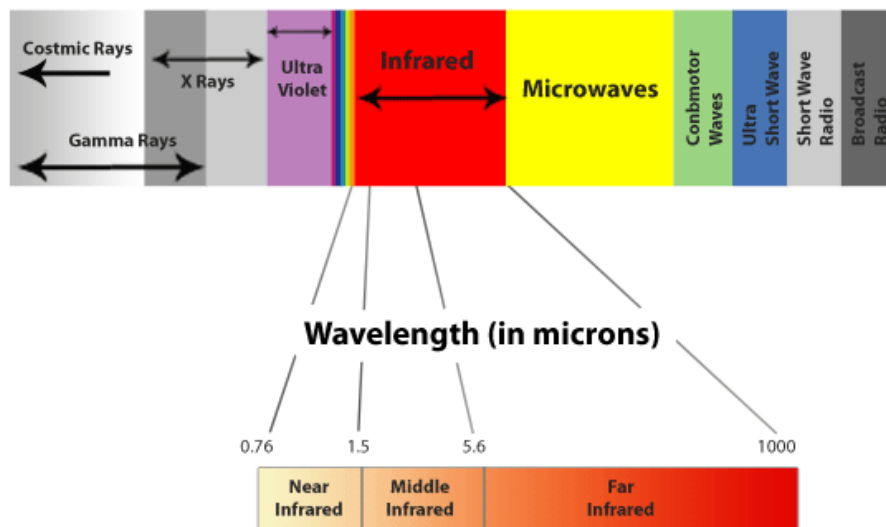

ARE INFRARED RAYS SAFE?

Because infrared rays are part of sunlight, they are not only safe but also highly beneficial to our bodies on a cellular level. Health professionals have used infrared heat lamps for decades to **treat muscle and joint problems**. In hospital baby care units, incubators are often equipped with infrared heating systems to **keep newborn babies warm**.

WHAT IS AN ELECTROMAGNETIC FIELD (also known as EMF)?

An Electromagnetic Field is a physical field produced by electrically charged objects. It is one of the fundamental forces of nature. The field can be viewed as the combination of an electric field and a magnetic field. The electric field is produced by stationary charges and the magnetic field by moving charges referred to as currents. The magnetic field is measured in milligauss (mG). Our sauna products have been developed to have low EMF. Our Low EMF carbon heater panels range between an average of 5mG-10mG at about two inches from the heater panel, our Ultra Low EMF carbon heater panels range between 3mG-5mG, and our Near Zero EMF/Full Spectrum

models range at less than 3mG (NIR heaters range at about 5mG-7mG at the same approximate 2 inches)

EMF Levels from Common Homes Sources

SOURCE	mG up to 4 inches	mG at 3 feet
Blender	50-220	0.3-3
Clothes Washer	8-200	0.1-4
Coffee Maker	6-29	0.1
Computer	4-20	2-5
Flourescent Lamp	400-4,000	0.1-5
Hair Dryer	60-20,000	0.1-6
Microwave Oven	100-500	1-25
Television	5-100	0.1-6
Vacuum Cleaner	230-1,300	3-40
Airplane	50	

Source: USA Environmental Protection Agency

After many years and numerous studies on EMF exposure, no government body including the Occupational Safety and Health Administration (OSHA) have established permissible exposure limits (PEL). Currently, there is no consensus on the potential health hazard from any exposure to EMF. The mainstream scientific evidence suggests that low-power, low-frequency, electromagnetic radiation associated with household currents like that of the infrared sauna does not constitute a short- or long-term health hazard.

DISCLAIMER

The infrared rays emitted by your sauna are reported to offer a wide range of possible therapeutic benefits based on research completed over the last 40 years from all around the world. These benefits are presented for reference purposes only and no implication of infrared saunas creating a cure for or treating any disease is implied nor should it be inferred. If you have a medical/health condition, are taking prescription drugs, or have acute joint injuries, please consult with your medical physician before using the sauna. Persons with surgical implants (metal pins/rods, artificial joints, silicone, or other types of surgical implants) typically do not experience any adverse effects, but should also consult their medical physician or surgeon before using the sauna room.

HOW IT WORKS

Infrared Saunas differ from traditional saunas in that they use infrared radiant energy to directly penetrate into the body's tissue to produce perspiration. Traditional saunas use steam to heat the air inside the sauna, which then heats your body until you begin to perspire. In order for this to be effective, temperatures would need to reach in the upwards of 190 degrees Fahrenheit. Infrared saunas only need a temperature of up to 120 degrees Fahrenheit to obtain the same effect. This lower temperature makes the environment more tolerable and allows you to breathe easier.

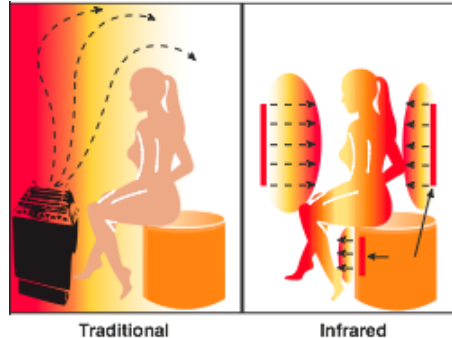

Health Benefits

Because infrared rays penetrate the body through conversion, there is a deep heating effect in both the muscle tissues and internal organs without putting too much burden on the heart.

Our body reacts to the increased heating through the natural cooling process of perspiring. Through the perspiration process, acid and waste residue like toxins, sodium, alcohol, nicotine, cholesterol, and the potentially carcinogenic heavy metals are removed from the cells (especially zinc, lead, nickel, cadmium, etc.). The pores of our skin open and discharge waste products shedding any old skin cells leaving the skin glowing and clean, with improved tone, elasticity, texture, and color.

Health Benefits Include, But Are Not Limited To:

- | | | |
|--|---------------------------|---------------------|
| *Pain relief from Rheumatoid Arthritis | *Relaxes muscle spasms | *Reduces cellulite |
| *Increases blood circulation | *Clears, rashes, acne | *Enhances skin tone |
| *Cardiovascular conditioning | *Reduces stress & fatigue | *Removes toxins |

Sauna Maintenance

Since infrared saunas do not require hot rocks, water, or steam to operate, they require very little maintenance. You can simply wipe it down with water – use a damp, soft, and clean cloth. **Do not use any chemical-based cleaning agents** as they can be absorbed into the wood and be released into your sauna during use.

READ ALL INSTRUCTIONS THOROUGHLY BEFORE ASSEMBLY

P6-H106-02 – Assembly Diagram

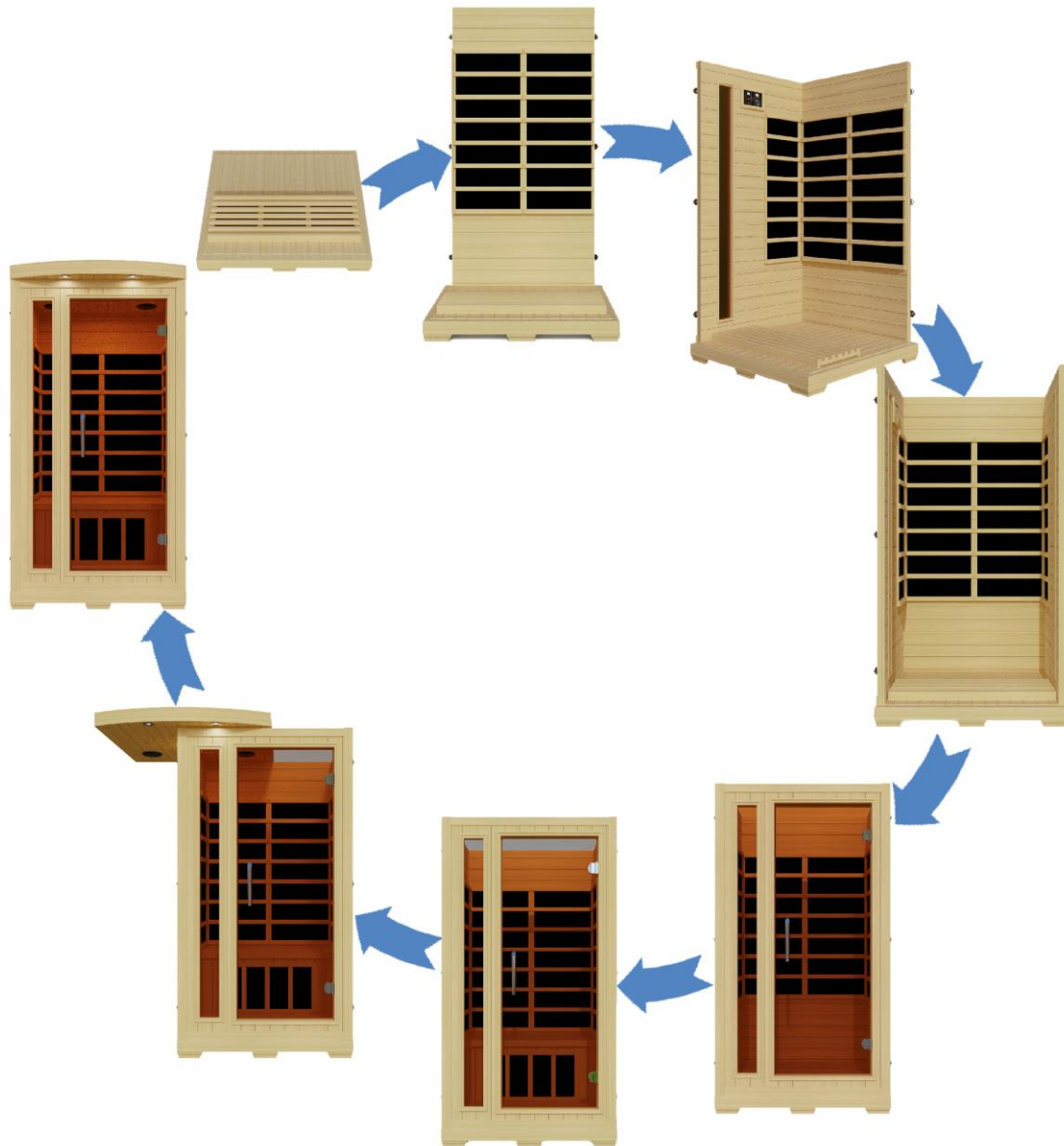

***THE ABOVE ASSEMBLY DIAGRAM IS FOR A QUICK REFERENCE VISUAL GUIDE ONLY. ALL SAUNA MODELS MAY NOT BE SHOWN. PARTS AND ACCESSORIES DO VARY AND ARE SUBJECT TO CHANGE. BACKRESTS NOT INCLUDED.**

READ ALL INSTRUCTIONS THOROUGHLY BEFORE ASSEMBLY

P6-H206-02 – Assembly Diagram

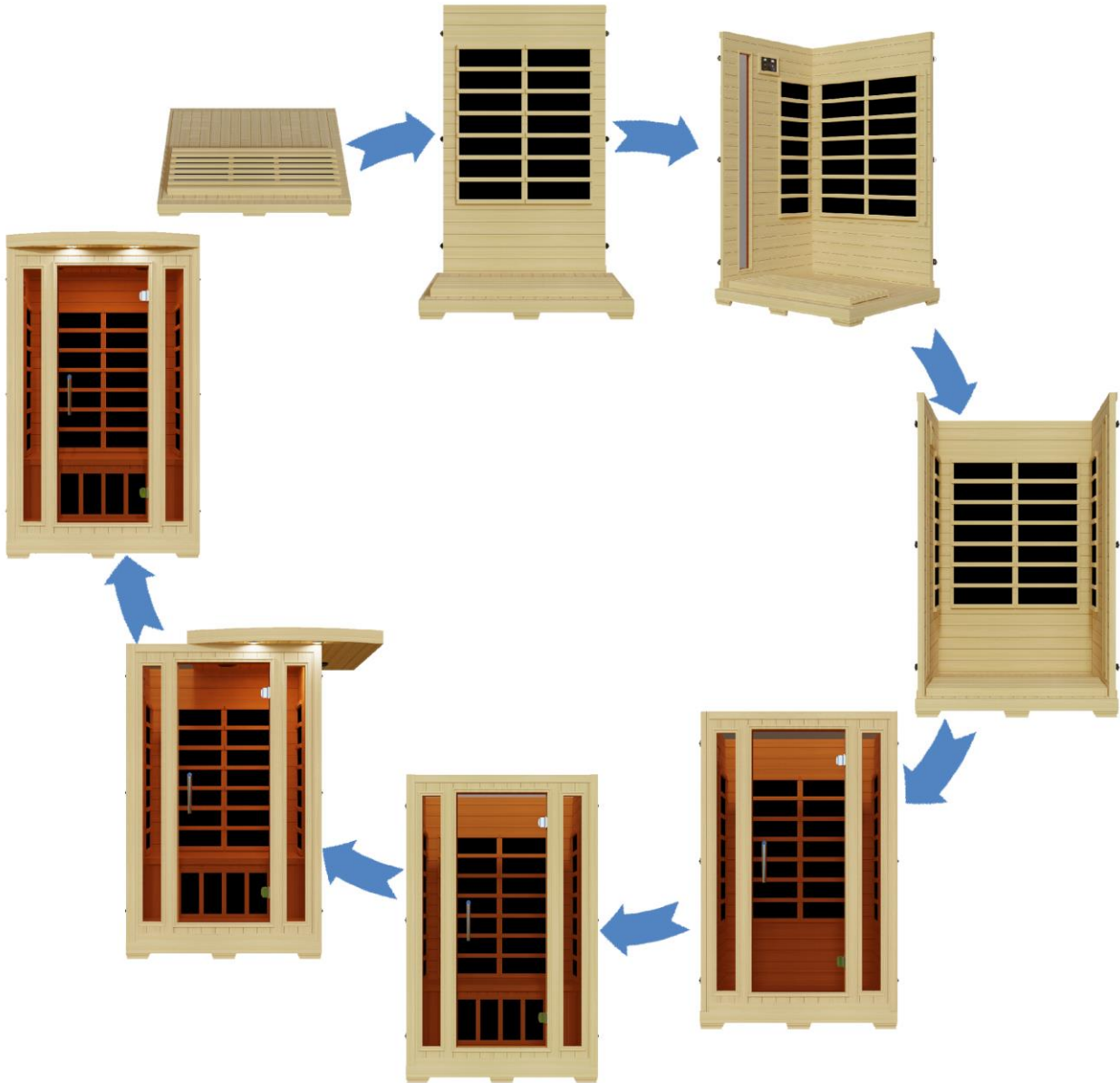

***THE ABOVE ASSEMBLY DIAGRAM IS FOR A QUICK REFERENCE VISUAL GUIDE ONLY. ALL SAUNA MODELS MAY NOT BE SHOWN. PARTS AND ACCESSORIES DO VARY AND ARE SUBJECT TO CHANGE. BACKRESTS NOT INCLUDED.**

READ ALL INSTRUCTIONS THOROUGHLY BEFORE ASSEMBLY

P6-H306-02 – Assembly Diagram

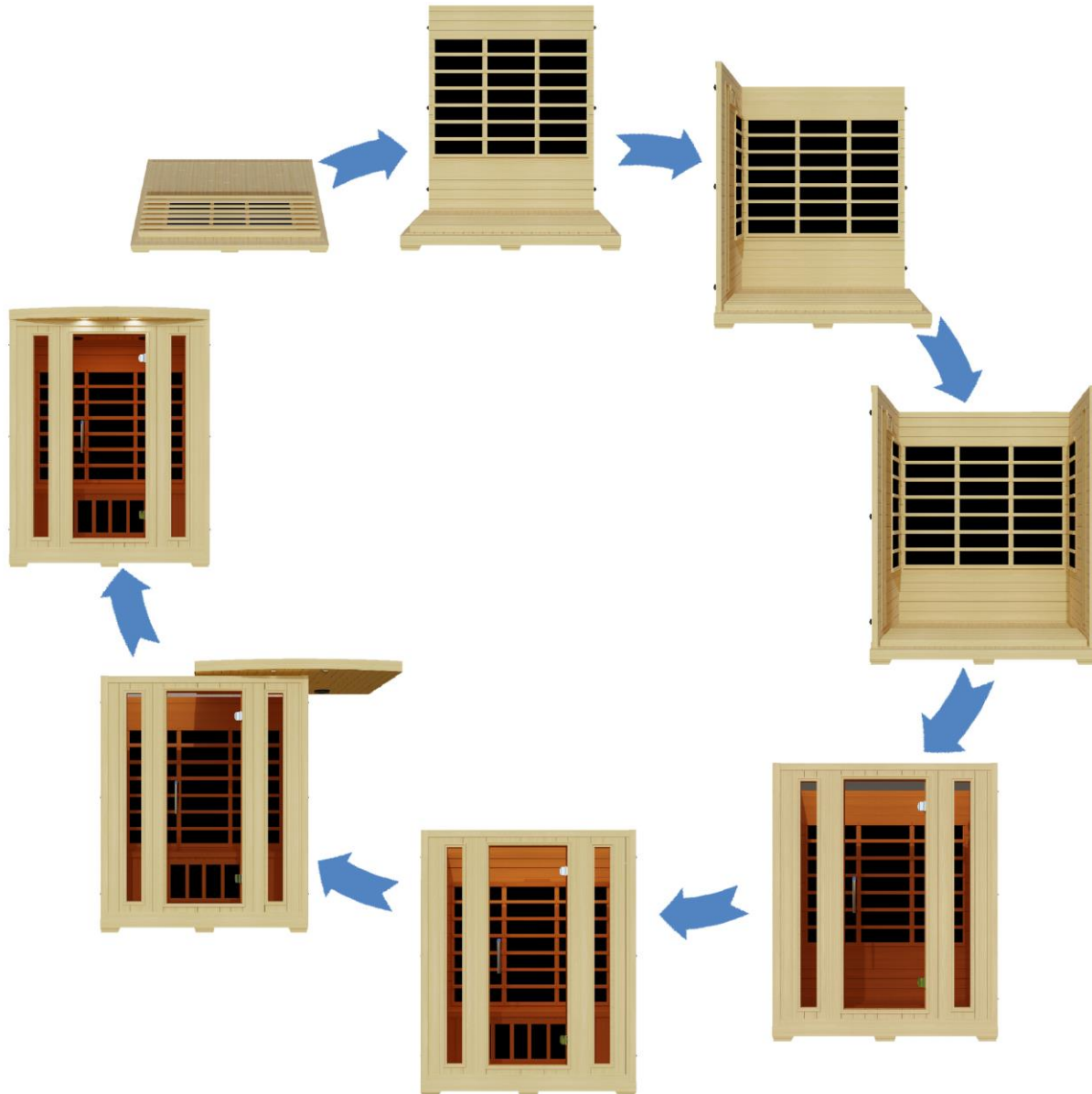

***THE ABOVE ASSEMBLY DIAGRAM IS FOR A QUICK REFERENCE VISUAL GUIDE ONLY. ALL SAUNA MODELS MAY NOT BE SHOWN. PARTS AND ACCESSORIES DO VARY AND ARE SUBJECT TO CHANGE. BACKRESTS NOT INCLUDED.**

READ ALL INSTRUCTIONS THOROUGHLY BEFORE ASSEMBLY

P6-H106-02 – Schematics

Electronic components			
No.	Name	No.	Name
1	Control panel	2	Speakers
3	Roof lights	4	Power supply
5	Red light Color light		

Power layout			
Location	No.	Dimension	Power
Left side panel	6	1000*400mm	300W
Rear wall panel	7	1000*400mm	300W
	8	1000*400mm	300W
Right side panel	9	1000*400mm	300W
Bench heater	10	700*300mm	200W
Floor panel	11	700*300mm	200W
Total			1600W

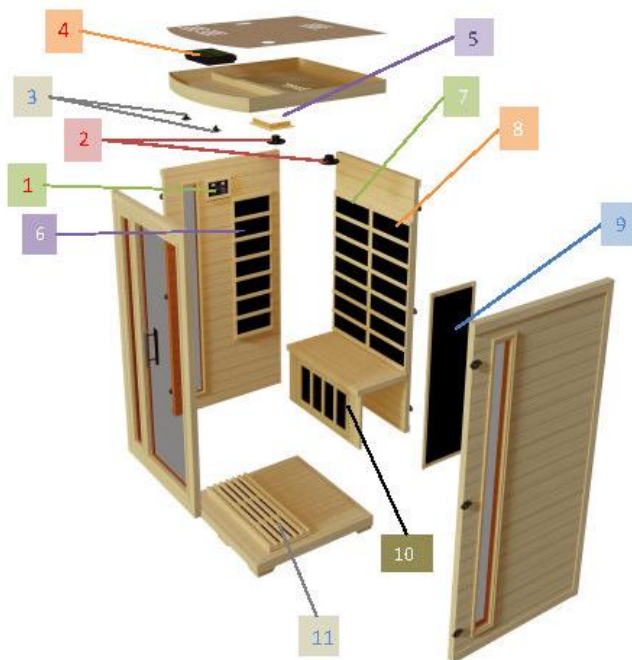

***THE PICTURES AND DIAGRAMS SHOWN WITHIN THIS OWNER'S MANUAL ARE REPRESENTATIONS OF THIS MODEL. ACTUAL MODEL MAY VARY. DESIGN AND CONSTRUCTION ARE SUBJECT TO CHANGE. BACKRESTS NOT INCLUDED.**

READ ALL INSTRUCTIONS THOROUGHLY BEFORE ASSEMBLY

P6-H206-02 – Schematics

Electronic components			
No.	Name	No.	Name
1	Control panel	2	Speakers
3	Roof lights	4	Power supply
5	Red light Color light		

Power layout			
Location	No.	Dimension	Power
Left side panel	6	1000*400mm	300W
Rear wall panel	7	1000*400mm	300W
	8	1000*400mm	300W
Right side panel	9	1000*400mm	300W
Bench heater	10	700*300mm	200W
Floor panel	11	1000*400mm	300W
Total			1700W

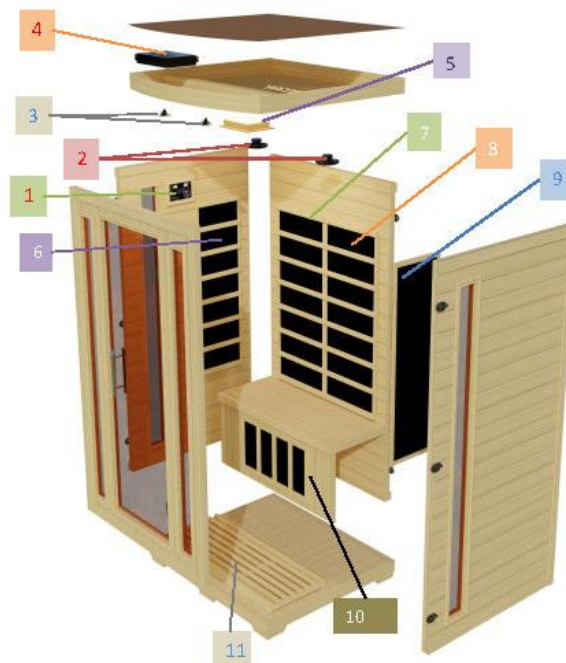

***THE PICTURES AND DIAGRAMS SHOWN WITHIN THIS OWNER'S MANUAL ARE REPRESENTATIONS OF THIS MODEL. ACTUAL MODEL MAY VARY. DESIGN AND CONSTRUCTION ARE SUBJECT TO CHANGE. BACKRESTS NOT INCLUDED.**

READ ALL INSTRUCTIONS THOROUGHLY BEFORE ASSEMBLY

P6-H306-02 – Schematics

Electronic components			
No.	Name	No.	Name
1	Control panel	2	Speakers
3	Roof lights	4	Red light Color light
5	Power supply		

Power layout			
Location	No.	Dimension	Power
Left side panel	6	1000*400mm	300W
Rear wall panel	7	1000*400mm	300W
	8	1000*400mm	300W
	9	1000*400mm	300W
Right side panel	10	1000*400mm	300W
Bench heater	11	1000*300mm	300W
Floor panel	12	1000*400mm	300W
Total			2100W

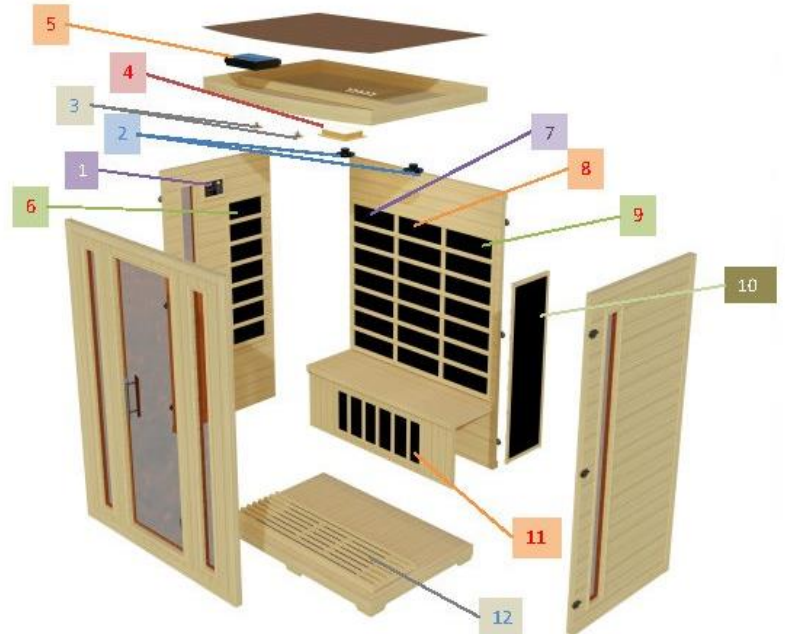

***THE PICTURES AND DIAGRAMS SHOWN WITHIN THIS OWNER'S MANUAL ARE REPRESENTATIONS OF THIS MODEL. ACTUAL MODEL MAY VARY. DESIGN AND CONSTRUCTION ARE SUBJECT TO CHANGE. BACKRESTS NOT INCLUDED.**

READ ALL INSTRUCTIONS THOROUGHLY BEFORE ASSEMBLY

P6-H106-02 – Schematic Layout

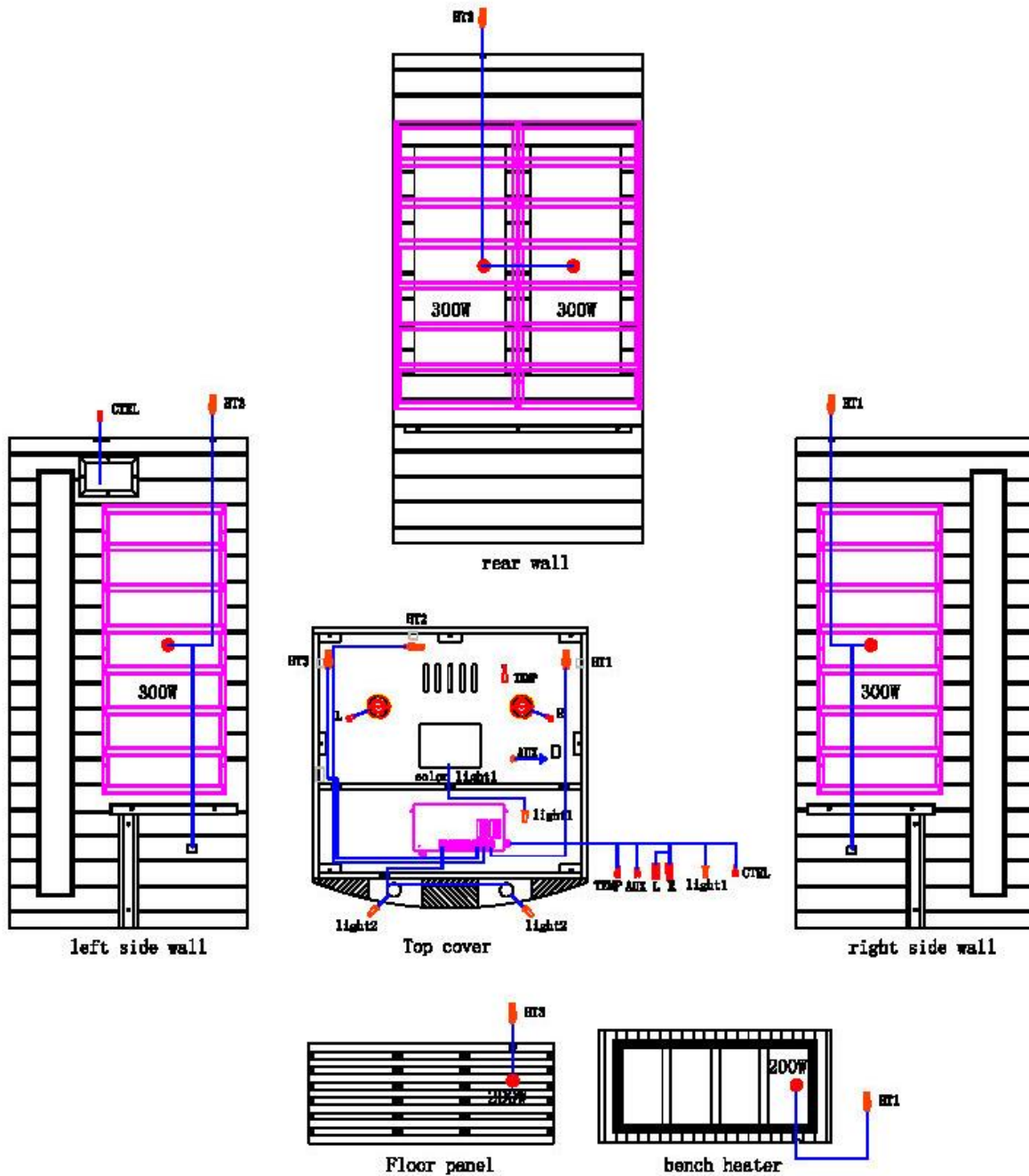

*THE PICTURES AND DIAGRAMS SHOWN WITHIN THIS OWNER'S MANUAL ARE REPRESENTATIONS OF THIS MODEL. ACTUAL MODEL MAY VARY. DESIGN AND CONSTRUCTION ARE SUBJECT TO CHANGE. BACKRESTS NOT INCLUDED.

READ ALL INSTRUCTIONS THOROUGHLY BEFORE ASSEMBLY

P6-H306-02 – Schematic Layout

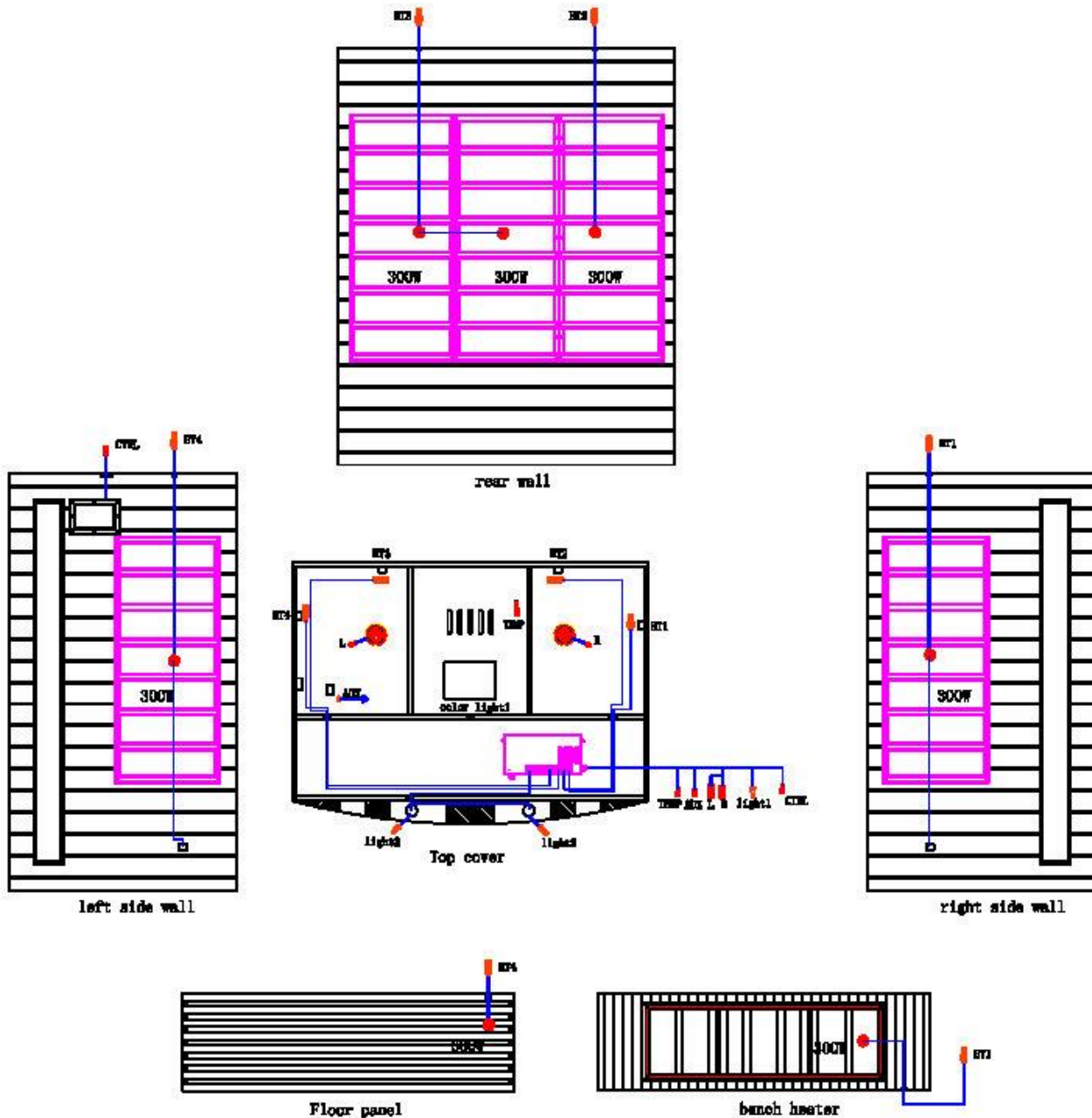

***THE PICTURES AND DIAGRAMS SHOWN WITHIN THIS OWNER'S MANUAL ARE REPRESENTATIONS OF THIS MODEL. ACTUAL MODEL MAY VARY. DESIGN AND CONSTRUCTION ARE SUBJECT TO CHANGE. BACKRESTS NOT INCLUDED.**

READ ALL INSTRUCTIONS THOROUGHLY BEFORE ASSEMBLY

P6-H206-02 – DIMENSIONAL DIAGRAM

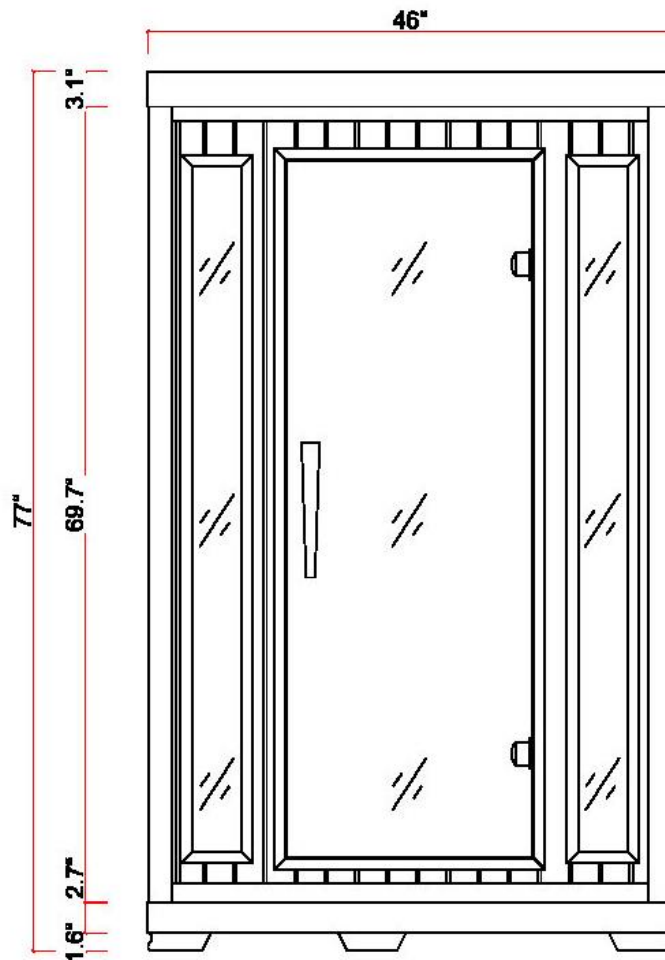
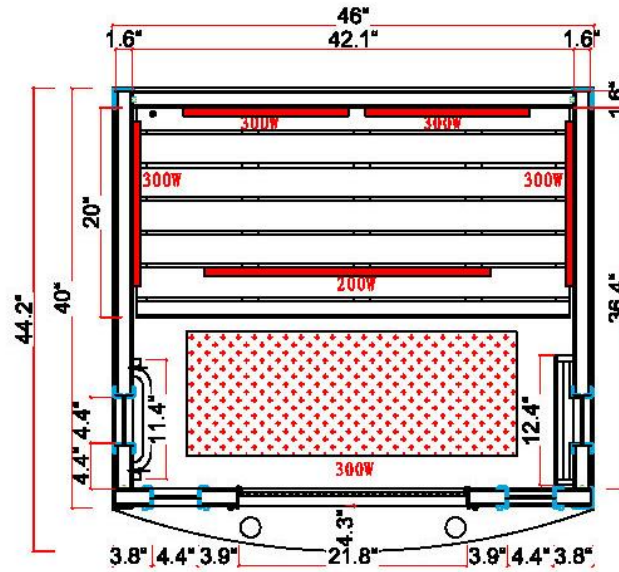

READ ALL INSTRUCTIONS THOROUGHLY BEFORE ASSEMBLY

P6-H306-02 – DIMENSIONAL DIAGRAM

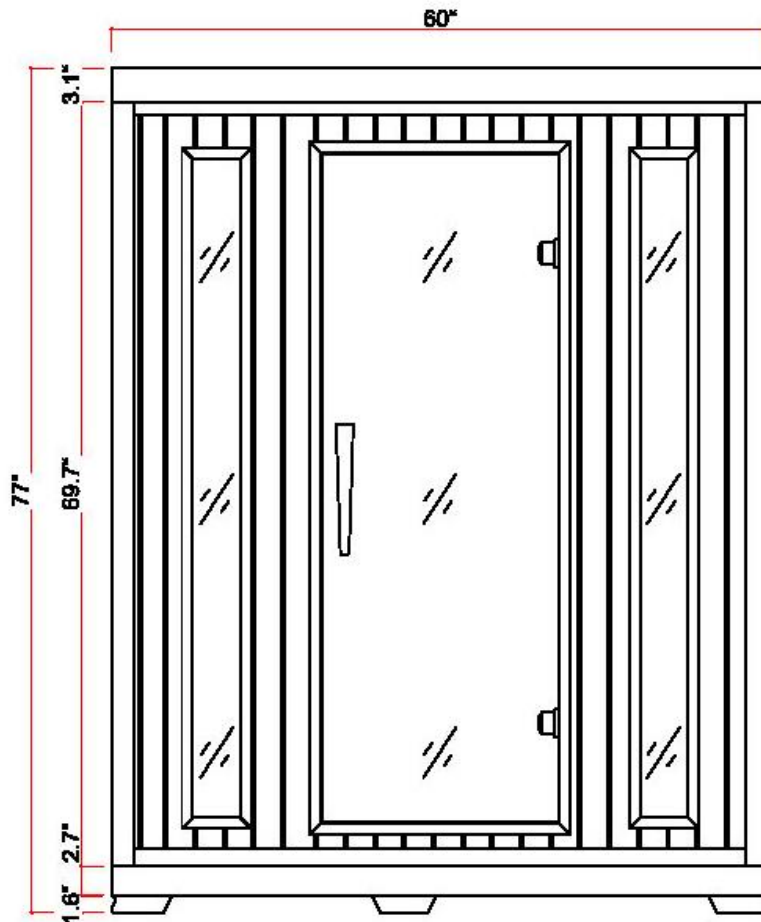
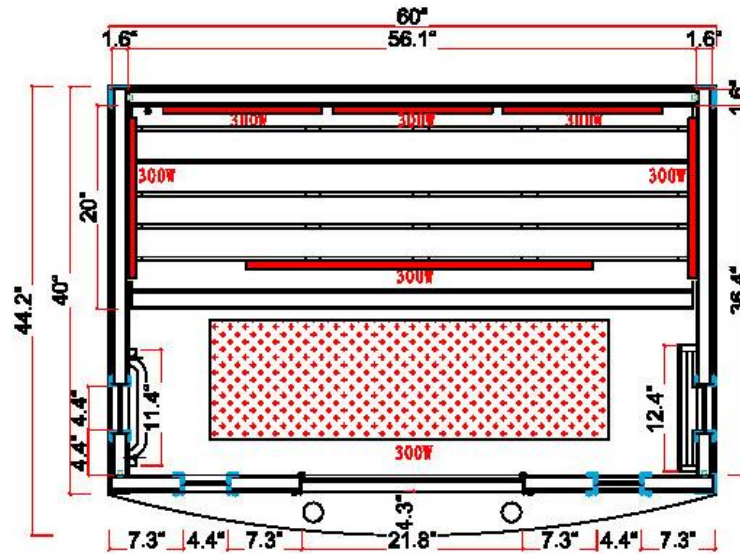

SCREW IDENTIFICATION AND LOCATION CHART

MODEL: P6-H106-02		
LOCATION	SPECS	USAGE
ROOF COVER	3x18mm(wood screw-gold color)	14
MP3 SHELF	3x18mm(wood screw-gold color)	2
TOWEL RACK	3.5x35mm(wood screw-gold color)	2
MAGAZINE RACK	3.5x35mm(wood screw-gold color)	4
FOOTREST	3.5x35mm(wood screw-gold color)	4
ROOF PANEL	5x50mm(wood screw-gold color)	8
BENCH	3.5x40mm(wood screw-gold color)	2

MODEL: P6-H206-02		
LOCATION	SPECS	USAGE
ROOF COVER	3x18mm(wood screw-gold color)	16
MP3 SHELF	3x18mm(wood screw-gold color)	2
TOWEL RACK	3.5x35mm(wood screw-gold color)	2
MAGAZINE RACK	3.5x35mm(wood screw-gold color)	4
FOOTREST	3.5x35mm(wood screw-gold color)	4
ROOF PANEL	5x50mm(wood screw-gold color)	8
BENCH	3.5x40mm(wood screw-gold color)	2

MODEL: P6-H306-02		
LOCATION	SPECS	USAGE
ROOF COVER	3x18mm(wood screw-gold color)	24
MP3 SHELF	3x18mm(wood screw-gold color)	2
TOWEL RACK	3.5x35mm(wood screw-gold color)	2
MAGAZINE RACK	3.5x35mm(wood screw-gold color)	4
FOOTREST	3.5x35mm(wood screw-gold color)	4
ROOF PANEL	5x50mm(wood screw-gold color)	8
BENCH	3.5x40mm(wood screw-gold color)	2

Highlights

- A. High quality craftsmanship
- B. Temperature control
- C. Timer
- D. Infrared carbon heat emitter panels
- E. Control Panel:

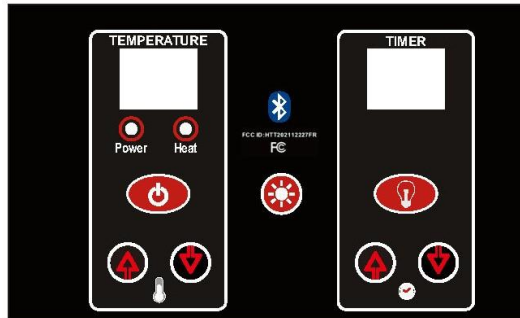

- F. Power supply and sub power supply:



- G. MP3 Jack:



- H. Buckles:

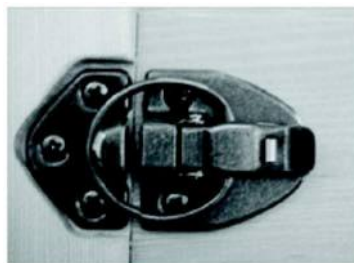

I. Panel Descriptions

For easier assembly, please understand and distinguish the differences between each panel.

a. **FLOOR PANEL**

When you place the FLOOR PANEL at its designated location, be sure to leave enough space so that you are able to move around the FLOOR PANEL during the assembly process. The wood guide inserts are located on the FLOOR PANEL at the front and rear. You will place the FRONT WALL PANEL and REAR WALL PANEL up snugly against the wood guide inserts on the FLOOR PANEL. Please note that there are two FLOOR PANEL styles: Style 1 will have the single FLOOR HEATER towards the front of the sauna room. Style 2 will have two FLOOR HEATERS and will have wood plank guides on the floor for the BENCH HEAT EMITTER PANEL. (see Figure 1)

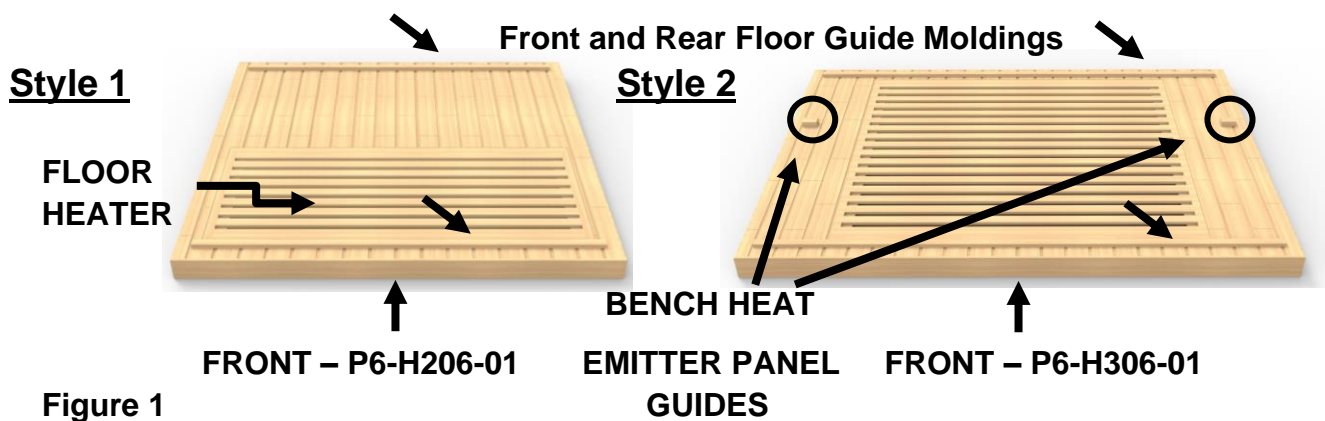

Figure 1

b. **Understanding the Difference Between the Top and Bottom of the Wall Panels**

The (4) panels are in the upright position when the heat emitter panels are closer to the top of the wall panel than the bottom of the wall panel. There will be 2 or 3 carbon heat emitter panels on the REAR PANEL depending on your model sauna. The REAR PANEL and SIDE WALL PANELS will have the heater cords coming from the top of each wall panel which will be connected once the ROOF PANEL is put on top. (see Figure 2)

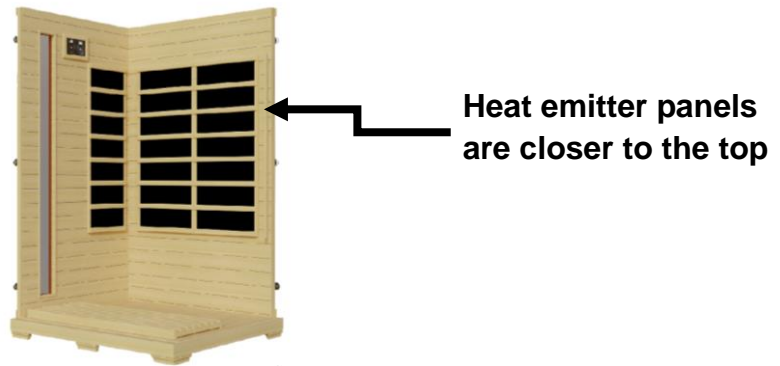

Figure 2

c. Roof Panel

The ROOF PANEL houses the power supply, speakers, MP3 AUX jack, and Chromotherapy Light. Once installed, all the wiring harnesses, plugs, and connections will sit on the exterior side of the roof panel.

READ ALL INSTRUCTIONS THOROUGHLY BEFORE ASSEMBLY

Assembly Instructions

Please note that your sauna has been completely assembled and tested at the factory prior to packaging. Please further note that the rear wall panel is intentional warped as part of the overall design. Two adults will be needed to assemble the sauna room.

A. Choose a good location to assemble the sauna

1. The location must be dry, leveled, and away from any source of water. The MAIN POWER cord should be easily accessible.
2. Two adults are required for installation.
3. Wood cabin installation order: Floor Panel - Front Wall Panel with Glass Door - Right Side Wall Panel - Left Side Wall Panel - Rear Wall Panel - Bench Heat Emitter Panel - Bench - Roof Panel - Roof Cover
4. Tools Required: Philips Screwdriver and Ladder

PLEASE NOTE THAT SOME MODELS WILL VARY IN ASSEMBLY.

B. Installing the FLOOR PANEL

1. Place the FLOOR PANEL on the floor. **SOME MODELS HAVE WOODBRACES THAT MUST BE INSTALLED ON THE UNDERSIDE OF THE FLOOR PANEL BEFORE ASSEMBLING THE SAUNA ROOM.** Please check to see if such wood braces were packed in the box containing the FLOOR PANEL. If so, mount according to the designated labels located on the underside of the FLOOR PANEL. Once installed, turn the FLOOR PANEL right side up. Make sure the front side of the FLOOR PANEL is facing the correct direction. (see Figure 1)

C. Installing the REAR WALL PANEL, RIGHT SIDE WALL PANEL, and LEFT SIDE WALL PANEL

1. Place the REAR WALL PANEL up and onto the FLOOR PANEL. Remove any protection paper/tape from the buckles if necessary and align the buckles on the REAR WALL PANEL and the LEFT SIDE WALL PANEL (or RIGHT SIDE WALL PANEL as the order of installing the side wall panels is not important). Once aligned, proceed in locking the buckles into place. Do the same for the RIGHT SIDE WALL PANEL (or LEFT SIDE WALL PANEL depending on which side you installed first). (see Figure 3 and Figure 4)



Figure 3



Figure 4

D. Installing the FRONT WALL PANEL

1. Remove any protection paper/tape from the buckles. Place the FRONT WALL PANEL up and onto the FLOOR PANEL. Next, attach the FRONT WALL PANEL to the LEFT SIDE WALL PANEL and use the buckles to latch together. Do the same for the RIGHT SIDE WALL PANEL. The black protection corners used to protect the corners of the glass door can be removed and discarded. (see Figure 5)



Figure 5

E. Installing the BENCH HEAT EMITTER PANEL and BENCH

1. Installing the BENCH HEAT EMITTER PANEL can be a little tricky on some sauna models. You will need to slide the BENCH HEAT EMITTER PANEL into place at an angle as indicated in the pictures below. (see Figure 6)
2. Plug in the BENCH HEAT EMITTER connector to the corresponding inlet located on the LEFT SIDE WALL PANEL.

Also plug in the FLOOR HEAT EMITTER PANEL connector to the corresponding inlet on the RIGHT SIDE WALL PANEL.

3. Install the BENCH at an angle as also seen in Figure 7. Then slide it over the BENCH HEAT EMITTER PANEL all the way back and against the REAR WALL PANEL. Make sure to install the BENCH with the smooth and finished side facing upward. Use the provided screws to screw the BENCH down at the pre-drill holes.



**BENCH HEAT EMITTER PANEL
Guides On Side Walls**

Figure 6

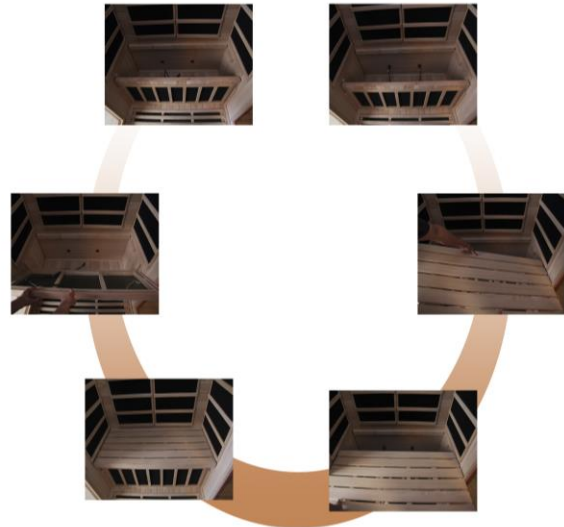

**(Bench & Bench Heat Emitter Panel
Do Vary In Installation & Design)
Figure 7**

F. Installing the ROOF PANEL

1. The side of the ROOF PANEL with the power supply (control box) is the top of the roof panel.
2. The edge nearest the power supply is the front of the ROOF PANEL. Be careful of the wires coming from the SIDE and REAR PANELS when you set the ROOF PANEL down onto the panels. Feed the wires through the holes in the ROOF PANEL. Feed the control cable and buzzer plug up through the ROOF PANEL.
3. Be careful not to force the ROOF PANEL into place. Make sure that the wires are properly fed through the holes. Furthermore, make sure the ROOF PANEL sits snugly onto all of the wall panels. Pull down on the ROOF PANEL slightly to make sure it is secured in place. It is optional to screw the ROOF PANEL down in residential use. (see Figure 8)



Figure 8

G. Connecting the plugs on the ROOF PANEL

1. Connect the plugs according to their respective labels on the rooftop.

H. Installing the TEMPERATURE SENSOR and optional accessories (varies by model)

1. Enter the sauna and remove the protective covering (masking tape) from the TEMPERATURE SENSOR. Please note that the black plastic section of the TEMPERATURE SENSOR is part of the TEMPERATURE SENSOR. Situate the TEMPERATURE SENSOR so that it is vertical and pointing downward. (see Figure 9)

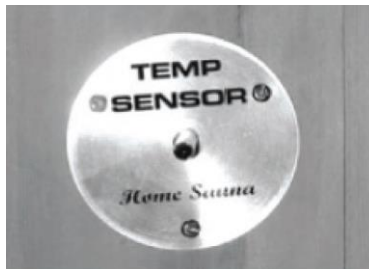

Figure 9

I. Putting on the ROOF DUST COVER

1. Place the ROOF COVER over the top of the sauna. Be cautious when pulling the power cord through the hole in the roof cover. Gently place the ROOF COVER onto the ROOF PANEL. When the edges are aligned, screw the ROOF COVER to the roof panel. Use the provided screws to screw down the ROOF DUST COVER. (see Figure 10)



Figure 10

J. Installing the DOOR HANDLE

1. The inner and outer door handles need to be mounted to the FRONT GLASS DOOR. According to Figure 11, the FRONT GLASS DOOR must sit between the (2) white washers. The screws are inserted from the inside of the FRONT GLASS DOOR and screwed into the outer handle. **Be sure not to over tighten the screws or you will shatter the glass.** Next, the inner door handle needs to be inserted over the screws. Use the provided Hex wrench to tighten the (4) hex screws. (see Figure 11)



Figure 11

2. If your sauna comes with the **optional** Magazine Rack, Shelf, and/or optional Towel Rack, use the screws provided to mount the Magazine Rack in the lower left-hand side of the interior FRONT WALL PANEL (in front of the glass window panel) and the Towel Rack to the interior RIGHT SIDE WALL PANEL. Furthermore, use the screws to mount the shelf on either side panels of the front panel where there are no heater panels. Please note that these accessories are **not** available on all models. (see Figure 12, 13, and 14)



Figure 12



Figure 13



Figure 14

ASSEMBLY COMPLETE!

Operating the Sauna

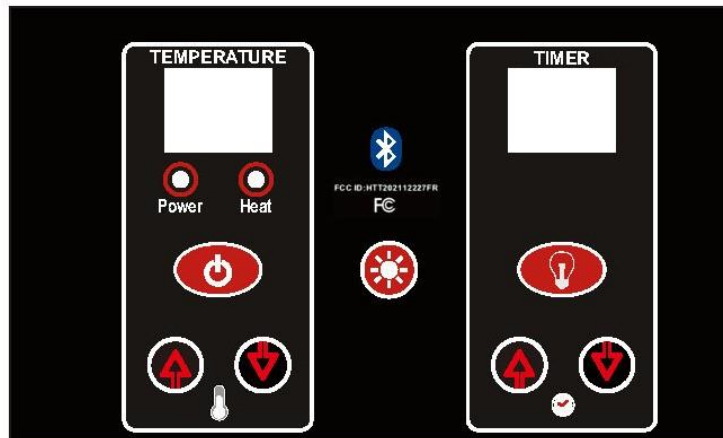



1. Precautions

- A. Please make sure your wall outlet meets the specifications required. Failure to meet the requirements may cause safety risks.
 - a. Set the temperature and time to a comfortable level. The average used temperature range is between 118°F – 122°F. The average sauna session is approximately 20 – 30 minutes. **You must pre-heat sauna room to the desired temperature before entering.**
Note: If the ambient temperature is below 68°F, the sauna will take longer to pre-heat. It is not recommended to use the sauna in an environment with an ambient temperature below 60°F.
 - b. Drink water prior to, during, and after your sauna session to replenish body fluids.
 - c. After 2 hours of continuous use, the sauna needs to be shut down for one hour.
 - d. To avoid burns, do not touch the heating element.

2. Operating The Sauna







- A. Review the electrical label on the sauna and then plug the sauna into the proper wall outlet. No other appliance can be operated on the same electrical breaker as the sauna when the sauna is in use. Proceed in turning on the sauna room using the ON/OFF button to activate the sauna.
- B. The sauna should be **unplugged** when not in use. If you do not have access to the plug, it is recommended to use a heavy-duty surge protector.



- C. **To set the temperature**, press the  temperature buttons to increase or decrease the temperature to the desired temperature. If the "Heat" light is on, the temperature setting will increase one degree every time the  button is pressed. If pressed for three seconds, the setting will





increase quickly. Decrease the temperature in the same manner by pressing the  button. After the sauna reaches the desired temperature, the “Heat” light will turn off.

D. Press the  button to turn the light ON. If you want to use the **Color Light Therapy System**:

1. While the interior light is ON, press and hold down the  button for 2 seconds. You will notice “2n” in the LED display. This indicates you are in the “light” mode. If you do not press any buttons for approximately 15 seconds, the “2n” will change back to the Timer mode.
2. While the “2n” is displayed, you can now turn the exterior light ON/OFF by pressing the  button in the  section of the control panel.
3. You can also turn the interior light ON/OFF by pressing the  button in the  section of the control panel.
4. While the interior light is on and the “2n” is still displayed in the LED display, you can press the  button to scroll through the different colors within the Color Light Therapy System. You will notice that you have two selections for “white”:
 - A. The first selection for “white” will allow the colors to go through a sequence of the different shades of colors.
 - B. The second selection for “white” will continue to display the white light.

5. To return back to the Timer mode, press the  button.

- E. You can operate the sauna with the ceiling vent in the open or closed position.
- F. After your sauna session is over, you can turn the control panel off by pressing the ON/OFF button. You can unplug the sauna cord or switch the heavy-duty surge protector to the OFF position.

G. To set the time, press the   buttons. Press  and  buttons to set the timer from 5 to 60 minutes. If pressed for three seconds, the timer will increase/decrease quickly. To extend the sauna session,



reset the timer again by pressing the

H. The Fahrenheit and Centigrade display can be switched by pressing

and holding the temperature button  and  at the same time and

then pressing the .

I. The Bluetooth function is built into the Control Panel. For the Bluetooth function, you first will need to pair your device with the sauna room. Open your device's Settings Menu and then locate and open Bluetooth. You will find "**BT-SAUNA**". Now you can pair your device. Once pairing is successful, your device will be connected. You will control the volume and choose the music on your device.

J. The MP3 Jack will allow you to connect your musical device using the AUX wire. Plug one end of the AUX wire into your musical device and the other end into the MP3 Jack at the ceiling. Do not leave the AUX wire connected at the ceiling when not using this function as it may cause static interference at the speakers. You will control the volume and choose the music on your device. When you disconnect the MP3 wire, the sound system will automatically return back to the Bluetooth mode.

CAUTION: Exit sauna immediately if you feel dizzy, sleepy, or any discomfort.

Tips for using Your Sauna

1. If you take a hot/warm shower or bath before using your sauna, you may perspire more and experience more comfort.
2. Drink water prior to, during, and after your sauna session to replenish body fluids.
3. To regulate the set temperature inside the sauna to your comfort level, use the movable roof vent or leave the door slightly open. The roof vent is installed on the sauna and used based on personal preference.
4. Use 2 towels during your sauna session. Fold the first towel several times and place it on the bench. As you sit on this towel, it will absorb a majority of your perspiration while adding comfort as you sit on the bench. Use the second towel to either constantly wipe the perspiration from your body to perspire faster and

also to avoid having too much perspiration dripping onto the floor. Never place any towels over the floor heater. If your legs become cold, you can use a third towel to drape over your legs to trap the heat.

5. This is a non-commercial sauna. For every three hours ON, the sauna must be turned OFF for one hour to cool down.
6. At the first sign of a cold or flu, increasing your sauna sessions may be beneficial in boosting your immune system and decreasing the reproductive rate of the virus.
7. To help relieve sore and tense muscles, massage the affected areas during your sauna session.
8. To treat your ankles and feet more effectively, you can elevate them and move them close to one of the heat emitters to achieve a deep heating effect.
9. To utilize the sauna's heat therapy effect, put oil and treatment into your hair and wrap it with a towel. After your sauna session is over, rinse your hair thoroughly.
10. The peaceful and relaxed state rendered by a sauna session may help you to sleep easier and deeper.
11. To conserve energy consumption, please unplug your sauna when not in use – especially if you do not plan on using the sauna for an extended period of time.
12. After the sauna session is over, do not jump into the shower or bath immediately. Because your body was heated up during the sauna session, it will continue to perspire even after the heat emitters are off. Sit in the sauna with the door slightly opened and let your body cool down. Once your body has cooled down and you feel comfortable, you can exit the sauna. After about fifteen minutes and when your body has completely cooled down, you can take a shower or bath to clean your body.

Safety Instructions

1. Read and follow all instructions carefully before using the sauna.
2. When assembling and using the electrical equipment, safety precautions should always be followed.
3. To reduce the risk of injury, do not allow children to use the sauna unless they are closely supervised at all times by an adult. Children should not use the sauna unless prescribed or advised by their medical doctor.
4. Do not use the sauna immediately following strenuous exercises. Wait at least 30 minutes to allow the body to cool down completely.
5. Pregnant or possibly pregnant women should contact their medical physician prior to using the sauna. Excessive temperatures have a high potential for causing fetal harm during pregnancy.
6. **Hyperthermia Danger:** The normal body temperature can't rise above 103°F (39°C). Symptoms of excessive hyperthermia include dizziness, lethargy, drowsiness, and/or fainting. The effects of excessive hyperthermia may include, but are not limited to failure to perceive heat, physical inability to exit the sauna, unawareness of impending hazards, unconsciousness, and/or fetal harm in pregnant women. Hyperthermia could make your body's core temperature rise.

Setting the desired temperature to an excessively high temperature is not recommended.

7. The use of alcohol, drugs, or medications (prescribed or non-prescribed) prior to or during the sauna session may lead to unconsciousness and/or other harmful physical injuries.
8. Persons suffering from obesity or with a medical history of heart disease, low or high blood pressure, circulatory system problems, diabetes, or other medical conditions should consult with a medical physician prior to using the sauna.
9. Persons using medications should consult with a medical physician before using the sauna. Some medications may induce drowsiness while other may affect the heart rate, blood pressure, and/or blood circulation.
10. Use care when exercising before and after sauna use.
11. Never sleep inside the sauna
12. Do not use any type of cleaning agents on the interior of the sauna. Only wipe down the sauna room with water and a damp cloth. Never use any chemical based cleaners.
13. Do not stack or store any objects on top of or inside the sauna.
14. If the power supply cord becomes damaged, it must be replaced immediately by the manufacturer or its agent. If you find the power cord is too hot (normally it will become warm) or that the electrical equipment may be experiencing technical problems, please contact the manufacturer or its agent immediately to avoid hazardous situations.
15. Make sure that the electrical outlet is in good working order. A common problem with electrical outlets is loose wiring on the connection points of the terminals of the outlet. A loose wire will also make for a bad connection and cause an unusual amount of heat buildup. Loose connections can also cause sparking in the junction box that can result in arcing. You'll likely see burn marks around the terminals if this occurs. If this happens, do not use the sauna and have the outlet replaced by a certified electrician. If the power cord is damaged, please contact Customer Support.
16. Do not use the sauna during an electrical storm to avoid risk of shock or injury.
17. Do not continuously switch the power ON and OFF excessively as it will compromise the life of the electrical components.
18. Your hands must be dry and free of moisture before plugging and unplugging cords and wiring harnesses from the power supply and circuit boards. Never operate the sauna with wet hands or wet feet to avoid the risk of electrical shock or injury. Never touch the metal prongs of the plug.
19. Do not attempt to make any repairs yourself unless authorized by the manufacturer or its agent. If a problem occurs with the sauna, please contact the manufacturer or its agent immediately to avoid safety risks. Unauthorized repair attempts will void the manufacturer's warranty.
20. Please make sure the outlet power supply meets the specifications required. Failure to meet the requirements may cause safety risks.
21. Some sauna models are equipped with reading and/or roof lamps. Because the lamp temperature will become very hot once powered ON, do not attempt to touch the lamp to avoid being burned. Do not attempt to touch it for at least 20

- minutes or until it cools down completely if a need to touch it arises.
22. Do not pour water or any other liquids onto the infrared heat emitters. Do not bump, hit, or break the heating elements as it may cause an electrical short and pose a safety risk.
 23. Do not make any modifications to the sauna, the sauna structure, or the sauna components.
 24. Prior to each sauna session, the sauna room is to be inspected for correct operation. If for any reason your sauna does not seem to be operating properly, discontinue use and contact Customer Service.

Safeguards For Your Sauna

1. Do not install the sauna near water, near a bathtub (if water will splash on the sauna), near a shower (if water will splash on the sauna), in a wet basement, or near a swimming pool (if water will splash on the sauna).
2. Do not use liquid cleaners or aerosol cleaners on the sauna. Unplug the sauna from the wall outlet before cleaning. Use plain water and a soft damp cloth for cleaning.
3. The power supply cord should be routed so that it is not walked on or pinched by any object that may be placed against it.
4. When replacement parts are required, be sure they meet the specified requirements of the manufacturer. Unauthorized substitutes may result in a fire, electrical shock, or other hazardous situations. After any repairs, please ask the service technician to perform a safety check to determine that the sauna is in good working order.
5. Do not use any wall receptacle adapter, surge protector, or extension cord between the sauna cord and wall outlet.

Troubleshooting Guide

	problem	possible reason	countermeasure
1	indicator light for power supply not working	The connector is not connected properly	Check the connector or replace a new one
		No power supply input	Check your circuit breaker to confirm power at the wall outlet
		Indicator light is broken	replace the circuit panel
2	Indicator light for function is not working	The heating indicator light is broken	Replace the relevant control panel
		The circuit board or components are broken	Replace the circuit board
		The temperature sensor is broken	check the connection of the temperature sensor
3	Infrared Heater not heating up	The heater is broken	Replace heater panel

		The wire junction or the heater's wire is not connected	Check that the connections are snug and tight
		The temperature sensor is broken	check the connection of the temperature sensor
		The circuit board or the relay is not working	replace the circuit board
4	Odor from the sauna	Power supply problem	Power supply may need to be replaced
5	Light bulb is not working	Light bulb is burned out	Remove burned out light bulb and replace it
		Light bulb wiring is loosen	Check connection and/or replace the lamp assembly
		Problems with electrical control panel	Replace the relevant control panel
6	Sauna is not powering up	Power cord is unplug	Plug the power cord into wall outlet
		Outlet has no power	Check your circuit breaker to confirm power at the wall outlet
		Power supply or circuit panel is broken	Replace the power supply or related circuit board
7	The temperature display shows "EP"	The connector of temperature sensor is loose, not connected, or sensor is damaged	Disconnect and reconnect the connector of temperature sensor or change to a new temperature sensor
8	The temperature display shows "H"	The temperature inside the sauna room is too high	Turn off the unit, and contact the manufacturer
9	Speaker does not work	The speaker is broken	Replace with a new one of the same specifications
		The speaker wire is loose	Disconnect and reconnect the speaker connections
		The power indicator light for CD is off	Turn on the switch to start work
10	Bluetooth Connection	Device will not connect to Bluetooth	Check your device and pair with BT-AUDIO
		Device will not connect to Bluetooth	You can only connect a single device at a time. Make sure you do not have any other device connected
		Device will not connect to Bluetooth	Reset the control panel by disconnecting the sauna's power cord from the wall outlet for 15 minutes
		Device will not connect to Bluetooth	Contact Customer Service

Maintenance

Do not use liquid cleaners or aerosol cleansers inside the sauna. Unplug the sauna from the wall outlet before cleaning. Use plain water and a soft cloth for cleaning. ***Do not use benzene, alcohol, or strong cleaning chemicals in or on the sauna.***

NOTE: Any chemical that can damage wood or be absorbed into the wood will damage the sauna.

Limited Lifetime Warranty

5 Year Limited Warranty*: Golden Designs, Inc. under the Dynamic brand name warrants the wood, structure, heating elements, and electronics against defects in material and workmanship for a period of 1 to 5 years from the original date of purchase. **This sauna is for INDOOR use only. Placing your sauna outdoors will VOID this warranty. Any damage due to exposure to outdoor elements such as rain, snow, sun, wind or extreme temperatures will not be covered by this warranty. Any damages as a result of modifications made to the sauna or its components will void this warranty.**

Extent of Warranty: This limited warranty applies to products manufactured or distributed by Golden Designs, Inc. under the Dynamic brand name, delivered in the continental United States or Canada and extends to the original purchaser at the original site of installation only. This warranty becomes valid at time of purchase and terminates either by specified time frame listed above, owner transfer, or relocation. **Your sales receipt showing the date of purchase of the product is your proof of purchase. Warranty is not transferable.**

Manufacturer Warranty

All Golden Designs, Inc. products are manufactured with the highest quality appliances and are warranted to be free from defects in material and workmanship at the time of delivery. The appliance warranty is extended through the manufacturer for the product including, but not limited to: stereos, CD/DVD players, etc. All exchanged parts and products replaced under this warranty will become the property of Golden Designs, Inc. Golden Designs, Inc. reserves the right to change manufactures of any part to cover any existing warranty. Any parts determined to be defective must be returned to Golden Designs, Inc. to obtain warranty service. You must prepay any shipping charges, export taxes, custom duties and taxes, or any other charges associated with the transportation of the parts. In addition you are responsible for insuring any parts shipped or returned. You must present Golden Designs, Inc. with proof of purchase documents (including the date of purchase). Any evidence of alteration, erasing or forgery of proof of purchase documents will be cause to **VOID** this limited warranty. Products on which the serial number has been defaced or removed is not eligible for warranty service. This warranty covers parts, but does not cover labor.

Warranty Limitations

This warranty does not apply if the unit has been subject to negligence, alteration, modification, misuse, abuse, repairs by non-Golden Designs, Inc. authorized personnel, inappropriate installations, or any case beyond the control of Golden Designs, Inc. invalidating this warranty including but are not limited to:

- Use of lacquer or paints
- Sauna and other Golden Designs, Inc. products accessories placed on non-approved surfaces

- Outdoor applications
- Normal wear and tear or weathering
- Use of product not in accordance with instructions
- Worn out receptacle

Surface cracks are not considered defects in material or workmanship, as they are normal characteristics of all woods. This includes minor cracks due to wood expansion and contraction. Note: Since the wood used in construction has been kiln dried, a certain amount of expansion and contraction occurs in the wood in a sauna environment.

Disclaimers

Golden Designs, Inc. shall not be liable for loss of use of sauna or other Golden Designs, Inc. products or other secondary or incidental or consequential costs, expense or damages - which may include the removal of permanent deck or other custom fixtures or the necessity for crane removal - arising directly or indirectly out of the use or inability to use the product. Any implied warranty shall have duration equal of the applicable warranty stated above. Under no circumstances shall Golden Designs, Inc. or any of its representatives be held liable for injury to any person or damage to any property, however arising. Specifications are subject to change without notice or obligation.

Legal Remedies

This limited warranty gives you specific legal rights. You may have other rights, which may vary from state to state.

Customer Service

For customer service, contact your authorized dealer. If you need additional information or assistance, please email Golden Designs, Inc. at info@goldendesignsinc.com or call (909) 212-5555.

*Limited Lifetime Warranty of Sauna Products is 5 years for residential use and 1 year for commercial use on heating elements and electronics from the date of purchase. The wood structure has a 1 year limited warranty.

PAGE INTENTIONALLY LEFT BLANK

WARRANTY CARD

Congratulations on your purchase of an Infrared Sauna from Golden Designs, Inc. Please take the time to complete the following Warranty Card and mail it back to:

**Golden Designs, Inc.
3550 Jurupa Street, Unit B
Ontario, CA 91761**

Please include a copy of your sales receipt showing date of purchase as this will serve as proof of purchase.

Warranty will be VOID if the following warranty card is not mailed back within 60 days of purchase date along with proof of purchase.

****Serial number (S/N) is located on the sauna’s front panel, rear panel, or on the carton.****

DETACH HERE



WARRANTY CARD

All fields must be completed to validate the

warranty. Name: _____

Address: _____

City: _____ State: _____ Zip Code: _____

Phone Number: _____

Purchase Date: _____

Purchase From: _____

Serial Number: _____

Serial Number: _____

