

# Red Cedar Barrel Sauna

2, 4, & 6 Person Models

GDI-B002-01/GDI-B004-01/GDI-B006-01



## OWNER'S MANUAL

**FOR BARREL MODEL SAUNAS**

**REQUIRES 120VAC 15 AMP CIRCUIT (FOR THE LIGHTING)**

Carefully and thoroughly read this Owner's Manual before using/operating the sauna. We recommend keeping this Owner's Manual for regular review and future reference. Follow your local codes and ordinances. The stove heater power requirements do vary among manufacturer. The stove heater must be installed by a certified licensed electrician per the manufacturer's manual. The stove heater must be installed per the electrical code in your area with reference to the breaker and wire sizes. Models are subject to change.

**Thank you for your purchase.** As you remove the parts from the boxes, be sure to examine them for damages. If your unit has any damages or missing parts, please contact Golden Designs Inc. See the Warranty section for more information.

A Certified Licensed Electrician will be needed to install the electrical wiring. Due to the heat of the sauna, it is required that copper wire with 90° Celsius rating be used. Aluminum wiring cannot be used in this application. Consult with your electrician regarding the electrical requirements in your area. All wiring must be in accordance with all national, state, and local codes and regulations. Your electrician will supply the needed wiring and connections.

Excluding models specifically designed to be placed directly in the outdoor weather elements, your sauna can be placed either indoors or outdoors. Sauna models without a specific outdoor roofing cannot be placed directly in the weather elements. These models, if placed outdoors, can be placed under a covered structural such as a patio. The barrel sauna models can be placed in the outdoors. Before assembling, make sure the surface in which the sauna will be placed on is level/dry and can support the weight of the sauna and its occupants. We recommend a concrete base or wood deck to support the sauna. If you will be placing the sauna directly on the ground, you must use such materials as concrete cinder blocks or other similar supporting structure to prevent the sauna from settling into the ground over time.

Once you have removed the parts from the boxes, you will want to take a look at the parts for identification. For the barrel saunas, you will want to carefully inspect the staves for placement. We do use a higher grade of wood, but wood is still a natural resource and you may find blemishes or knots. You will want to use the less attractive staves on the floor instead of higher up on the walls.

For sauna models specifically designed to be outdoors, the wood can withstand the weather elements with proper maintenance. The outdoor model saunas were designed to be placed in the sun, rain, and snow. Depending on the severity of the weather elements in your area, you will want to apply an exterior wood water repellent treatment within a month of assembly and 2-3 times per year from there on. Please note that the natural weathering elements will change the color of the wood over time. For barrel saunas and other sauna models placed directly in the weather elements, you will have some water seepage, especially at the top and sides due to the porous characteristics of the wood and how the staves and wood planks fit together. The water seepage will not damage the sauna and usually dries quickly when the sauna is in operation.

**FOLLOW ALL INSTRUCTIONS AND BE CAUTIOUS OF SAFETY SYMBOLS. All electrical wiring must be performed by a qualified licensed electrician. While the barrel sauna comes in different sizes and features, the information within this manual is applicable to each.**



**High Voltage Symbol:** Be cautious as there is the presence of a high voltage current that flows through the equipment!



**General Caution Symbol:** Be cautious as the equipment uses electrical current that can cause serious injury.

**ATTENTION**

**⚠ WARNING**

1. Please read this Owner's Manual thoroughly before use. This will allow the user to become familiar with the operation of the control system. Please keep the Owner's Manual available for future reference. If any technical assistance or repairing is needed, please contact the manufacturer.
2. The sauna can be installed outdoors. Please note that water will seep between the staves due to the porous nature of the wood. When not in use and placed outdoors, a rain cover is recommended to cover the sauna room if your model does not come with an actual outdoor roof. Please note that water seepage will not hurt the wood and will usually dry quickly due to the heated environment. If you want to keep the sauna completely dry, you will need to install the sauna under a covered structure.
3. To reduce the risk of electric shock and/or fire, do not expose the control system to direct water contact or rain. Do not open the cover to the control system as there are high tension fittings that can be dangerous. Only dealer authorized qualified technicians should make any needed or necessary repairs at any time.
4. Any repairs, alterations, or modifications to the control system are not authorized unless by an approved repair technician. Any non-authorized repairs, alterations, or modifications can lead to serious injuries and can cause the unit to work outside its intended specifications parameters.
5. Any non-authorized repairs, alterations, or modifications will void the warranty.
6. Before connecting the unit to a power source, please make sure that all wires, cords, and connections are connected properly. If there are any concerns, please consult with a certified electrician.
7. Make sure that the sauna is placed in a well-ventilated area. It should not be placed in an area with other thermal-radiating objects. Make sure that the vents will not be obstructed for proper air flow.
8. When the equipment is not going to be used for an extended period of time, you can shut the main power source to the sauna or turn OFF the dedicated circuit breaker.

9. Allow 30 seconds between turning the control system “On” and “Off”. By allowing 30 seconds between powering the control system “On” and “Off” will prolong the life of the unit.
10. Confirm that you adhere to the correct power requirements of the control system. Connecting the control system to other than the required voltage can damage the control system and possibly cause serious injury. It is very important that the load parameters are consistent with that needed by the control system. Always consult with a certified electrician.
11. Red Cedar Wood and its rich aroma can cause an extremely small percentage of the population to have an adverse reaction known as Multiple Chemical Sensitivity (MCS). While this is not a universally recognized disorder in the medical field, certain consumers have an adverse physical reaction to low levels of many common chemicals and cannot tolerate any aromatic oils, shampoos with perfumes infused or certain herbs with natural aromas. However, for the majority of the population, Canadian Red Cedar is the sauna wood of choice.
12. Children must use the sauna under the care of adults and only after consulting with a medical doctor. Never play in or around the sauna. Never put animals into the sauna room.
13. The power cord and plug must be located out of the reach of children and away from any water source. Please consult with a certified electrician for safety concerns.
14. Never insert body parts or any other objects into the heater. Never put any foreign objects on or in the heater. Please follow the heater instructions and safety precautions.
15. Never use or store flammable liquids/gases near or inside the sauna.
16. Never store items or objects on top of the sauna.
17. Never use the sauna or heater if the power cord is damaged. Contact Customer Service immediately and do not use the sauna.
18. Never touch the heater parts or any electrical parts with wet hands.
19. Never use the sauna in a weather storm.
20. Make sure that the barrel sauna sits on a level surface and the surface can support the weight of the sauna (when filled with users) which can exceed 1000 lbs. A concrete slab, concrete pavers, gravel, cinder blocks, or solid wood deck is always best for outdoor installations. In addition, be sure that the support cradles rest on cinder blocks or other structures so as to prevent sinking/settling into the ground.
21. Never complete unauthorized repairs on the sauna or the heater.
22. For every (4) hours of use, the sauna should be shut down for (1) hour to prevent overheating and premature deterioration of the equipment.
23. Never use the sauna in combination with alcohol, medication, or drugs.
24. Pregnant women should never use the sauna. Women should also not use the sauna during their menstrual cycle.

- 25.** If you have any medical condition, you must consult with your medical doctor before using the sauna.
- 26.** Be cautious not to over extend yourself after an intense exercise workout by using the sauna. You can let the body cool down for 10 - 20 minutes before entering the sauna. Do not spend more than 40 minutes in the sauna at any one time.
- 27.** Prolonged exposure to high temperatures can cause burns. Stop using the sauna immediately if you experience overheating, dizziness, weakness, sleepiness, or fainting.
- 28.** Consult with your medical doctor before using the sauna if you suffer from diabetes, blood circulation disease, blood pressure issues, heart disease, or obesity.
- 29.** Watch your head when enter and exiting the sauna.
- 30.** Never clean the sauna with chemical-based cleaners or detergents. You can clean the sauna with any non-toxic, water based cleaner.
- 31.** Make sure the vents are always unobstructed.
- 32.** Being that the sauna will operate in different climates (some areas are colder than others), it is not recommended to use the traditional sauna above 190 degrees Fahrenheit / 88 degrees Celsius.
- 33.** To avoid a hazard, do clean the sauna floor of all perspiration and debris after each sauna session.

# READ ALL INSTRUCTIONS THOROUGHLY BEFORE ASSEMBLY.

## TABLE OF CONTENTS

Components	7
Basic Dimensions	20
Assembly Instructions	29
Using the Barrel Sauna	41
Tips for Using Your Sauna	41
Safety Instructions	42
Safeguards for Your Sauna	44
Troubleshooting	45
Warranty	46
Warranty Registration	48

**WARNING:** Visually inspect all heaters before assembly to make sure they are not damaged. Any excessive vibrations during transport could cause damage to the heating elements. **DO NOT START** the sauna if damage is detected! Contact your dealer or manufacturer for troubleshooting and replacement parts. The wood is naturally resistant to the weather elements, but the weathering elements can affect the wood over time.

**PLEASE NOTE:** The pictures and diagrams shown within this owner's manual are representations of this model. Actual models may vary. Design and construction are subject to change. If installed outdoors and over time, water may seep between the gaps of the construction. This would be considered normal. When not in use and placed outdoors, a water proof cover is recommended to cover the sauna room.

**CAUTION:** Exit sauna immediately if you feel dizzy, sleepy, or any discomfort.

# Components GDI-B002-01 (SJ-8141)

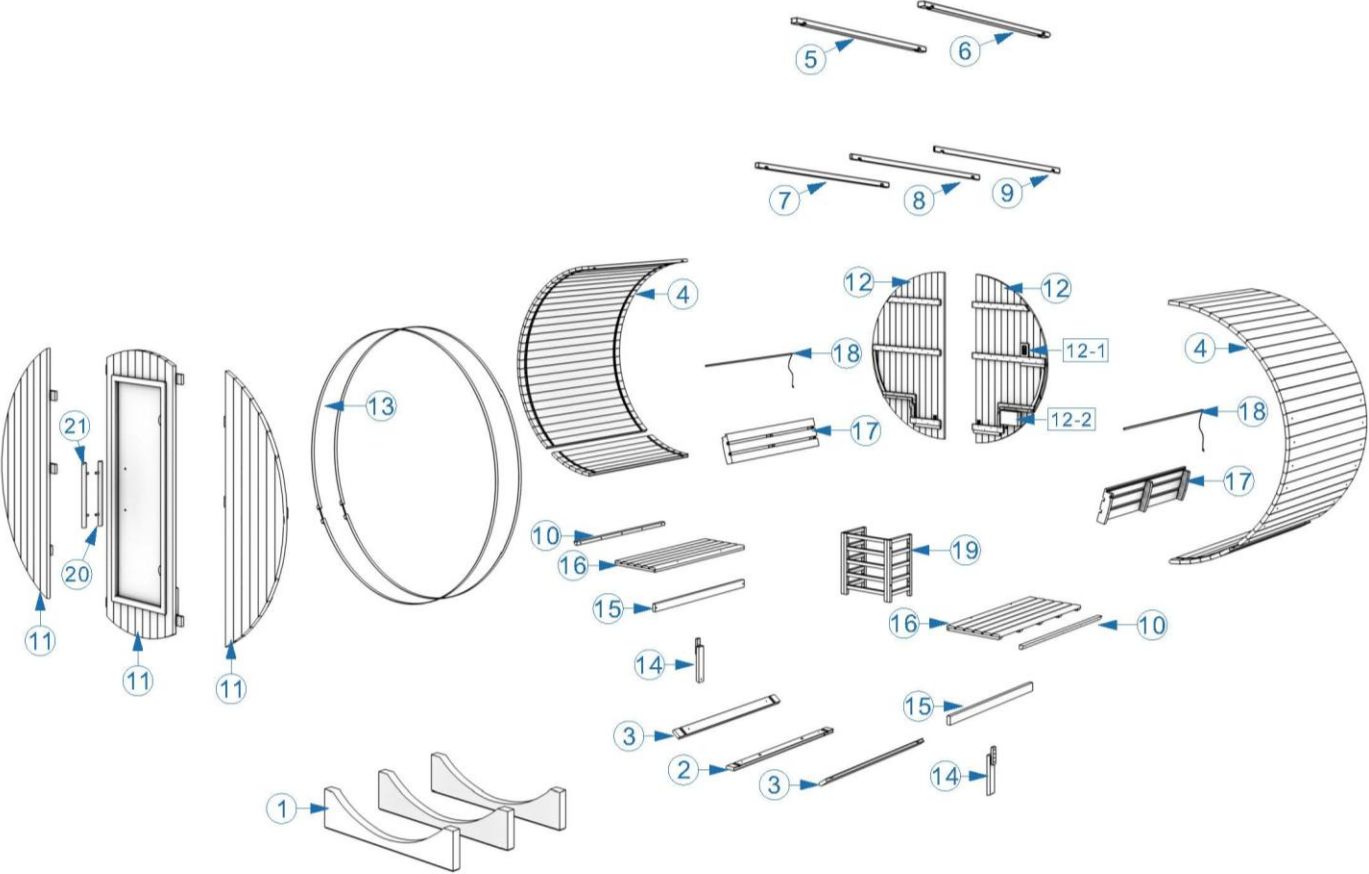

**\*The above assembly diagram is for a quick reference visual guide only. All sauna models may not be shown. Parts and accessories do vary and are subject to change.**

# GDI-B002-01 (SJ-8141) – cont'd

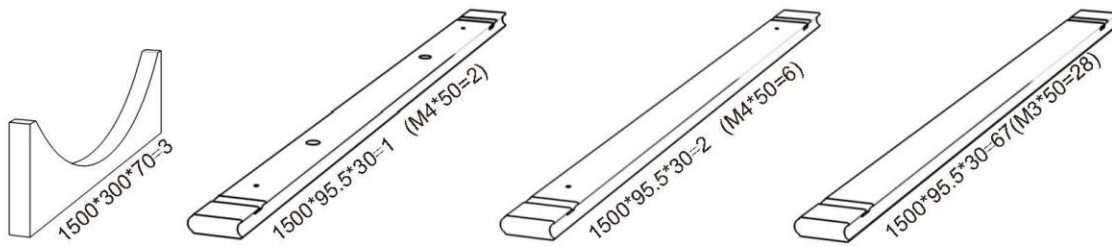

1 Cradles  
 2 The First bottom Stave (with two drain holes and 2 pre-drilled holes)  
 3 The 7th bottom staves (with 2 pre-drilled holes)  
 4 Standard staves

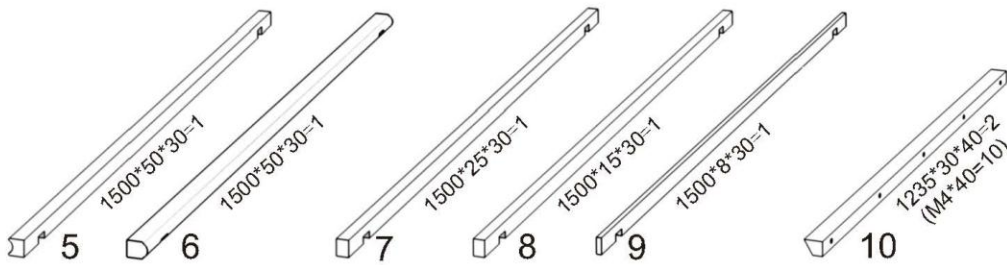

5 2 pcs top filling staves (Width:50mm;50mm)  
 6  
 7 3 pcs top filling staves (Width:25mm;15mm;8mm)  
 8  
 9  
 10 Bench back wood plank

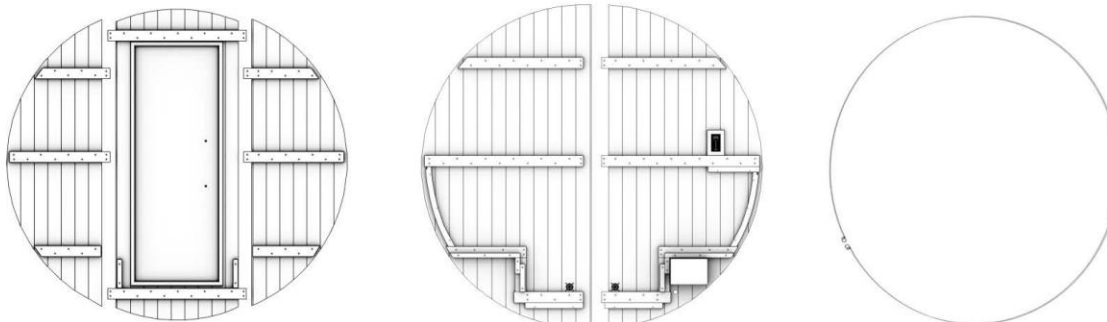

11 2006\*791+104\*30+20=1 (M4\*40=8)  
 1850.2\*615.5+52.2\*30+20=2 (M4\*40=8)  
 Front wall panel  
 12 2006\*1054.5\*30+40=1  
 2004.1\*959.5+42.9\*30+40  
 (M4\*40=6)  
 Rear wall panel  
 13 6352\*24\*0.5=2 (M195\*10=2)  
 Stainless steel band

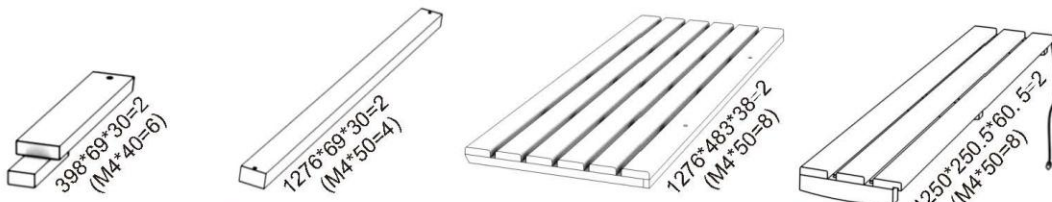

14 Bench support wood  
 15 Bench front wood plank  
 16 Bench  
 17 Backrest with Accent Light

**\*The above assembly diagram is for a quick reference visual guide only. All sauna models may not be shown. Parts and accessories do vary and are subject to change.**

# GDI-B002-01 (SJ-8141) – cont'd



18 554\*300\*35=1  
364\*300\*35=2(M4\*40=8)  
Stove guard



19 500\*35\*70=1  
Door handle



20 450\*30\*50=1  
(M6\*70=2)  
Door handle



21 1530\*3400\*1=1(M11\*11=24)  
Rain cover



22 \*2  
Hole metal cover



23 \*4  
Spacer



24 \*4  
Nut



25 \*4  
Plastic cover

26



M6\*70=2  
Stainless steel screw for handle

27

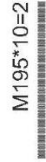

M195\*10=2  
Shaft

28



M3\*50=28  
Stainless steel Nail

29



M11\*11=24  
Pushpin

30



M3.5\*25=3  
Stainless steel screw

31



M4\*40=46  
Stainless steel screw

32



M4\*50=28  
Stainless steel screw

33



Screw driver for handle

34



Leveler

35



Mallet for adjust stave, not for screw

36



Bucket

37



spoon









38



Sandglass

**\*The above assembly diagram is for a quick reference visual guide only. All sauna models may not be shown. Parts and accessories do vary and are subject to change.**

## GDI-B002-01 (SJ-8141) – cont'd

ITEM#	IMAGE	PARTS LIST FOR GDI-B002-01 (SJ-8141)
1		<b>M3*50=28pcs</b> The 9th stave in every other stave through 21th stave: 14pcs
2		<b>M11*10=30pcs</b> Rain cover:30pcs
3		<b>M3*25=4pcs</b> Sandglass: 2pcs Thermometer:2pcs
4		Stove guard: 8pcs Bench wood back plank:10pcs Bench support wood:6 pcs front wall panel: 12pcs rear wall panel: 6pcs
5		Hex screw driver=1pc For bolts
6		Bench: 8pcs Backrest:8pcs Bench front wood plank: 4pcs The first stave: 2pcs The 7th stave on the right and left: 6pcs
7		<b>M6*70=2pcs</b> Door handle: 2pcs
8		Stainless steel screw-wide teeth for bands: 2pcs

\*The above assembly diagram is for a quick reference visual guide only. All sauna models may not be shown. Parts and accessories do vary and are subject to change.

# Components GDI-B004-01 (SJ-8241)

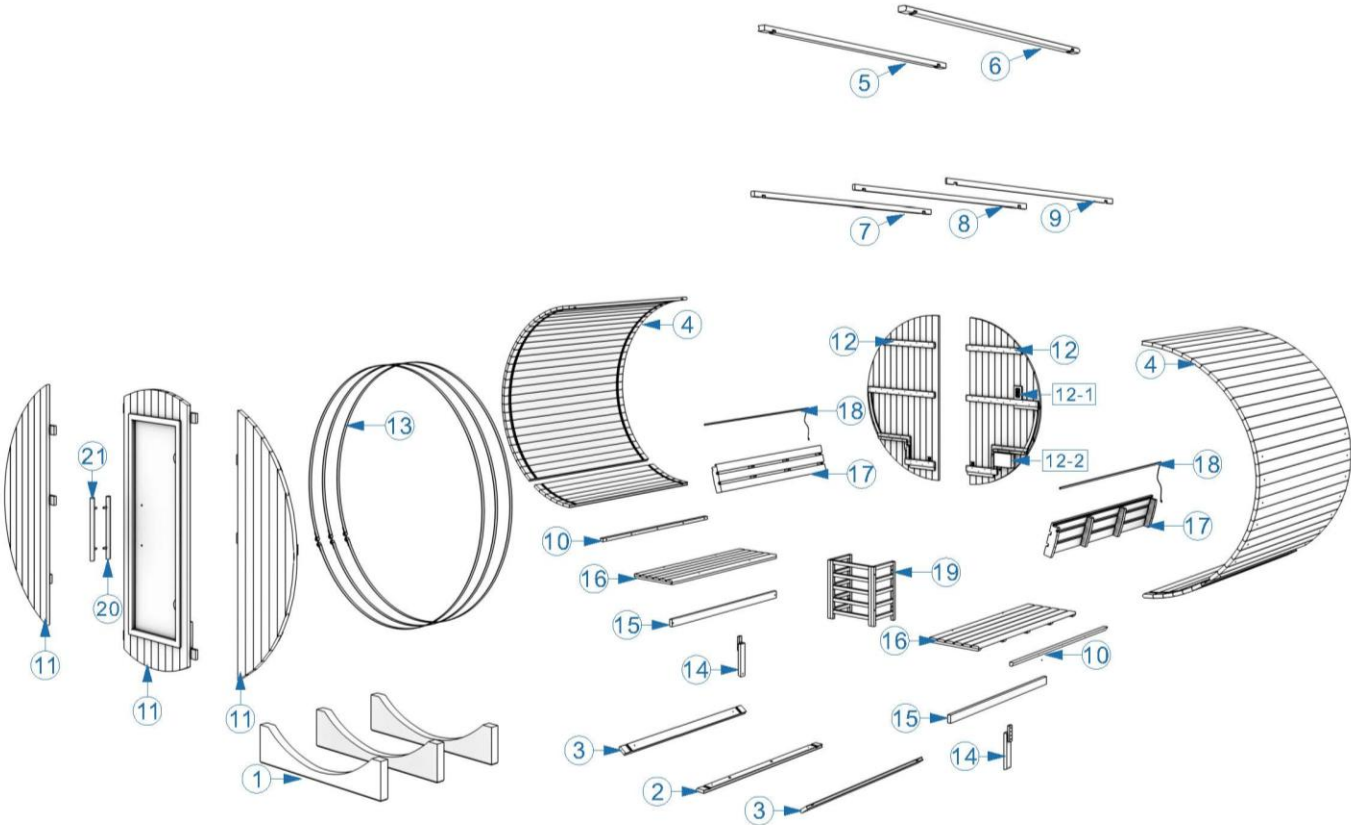

**\*The above assembly diagram is for a quick reference visual guide only. All sauna models may not be shown. Parts and accessories do vary and are subject to change.**

# GDI-B004-01 (SJ-8241) – cont'd

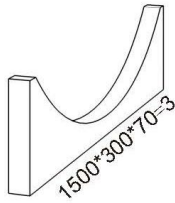

1 Cradles

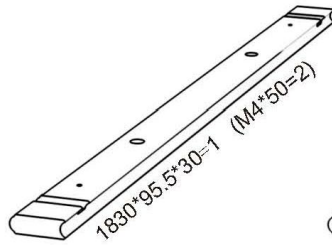

2 The First bottom Stave  
(with two drain holes  
and 2 pre-drilled holes)

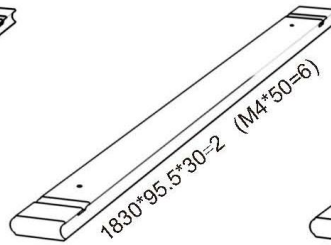

3 The 7th bottom staves  
(with 2 pre-drilled  
holes)

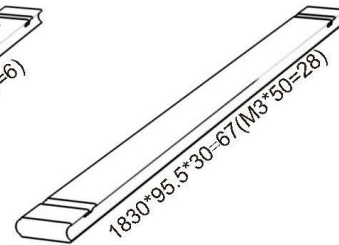

4 Standard staves

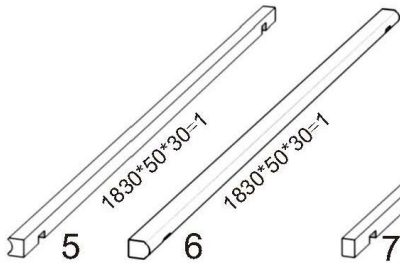

5 2 pcs top filling staves  
(Width:50mm;50mm)

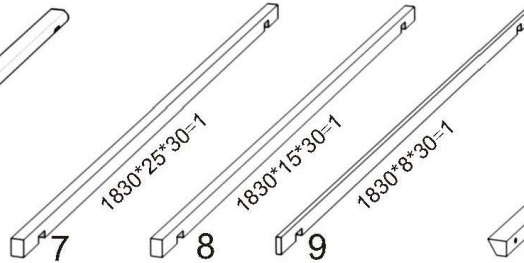

6 3 pcs top filling staves  
(Width:25mm;15mm;8mm)

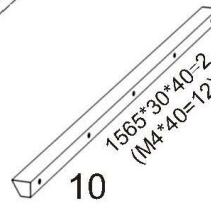

10 Bench back wood plank

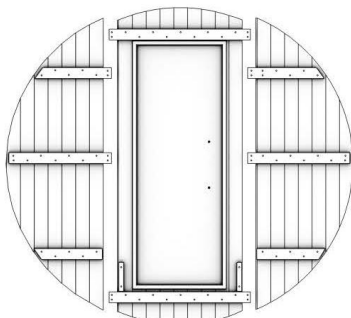

11 2006\*791+104\*30+20=1 (M4\*40=8)  
1850.2\*615.5+52.2\*30+20=2 (M4\*40=8)  
Front wall panel

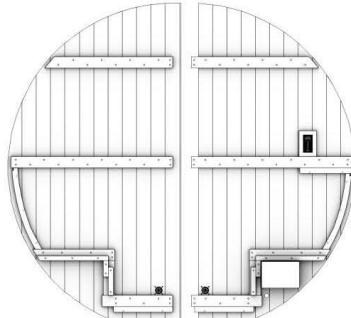

12 2006\*1054.5\*30+40=1  
2004.1\*959.5+42.9\*30+40  
(M4\*40=6)  
Rear wall panel

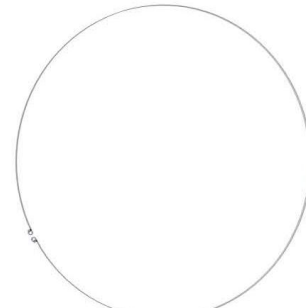

13 6352\*24\*0.5=3 (M195\*10=3)  
Stainless steel band

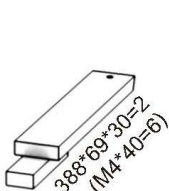

14 Bench support wood



15 Bench front wood plank



16 Bench

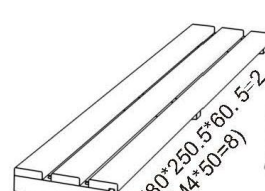

17 Backrest with Accent Light

**\*The above assembly diagram is for a quick reference visual guide only. All sauna models may not be shown. Parts and accessories do vary and are subject to change.**

# GDI-B004-01 (SJ-8241) – cont'd

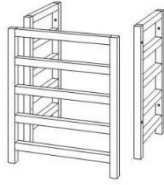

18 554\*300\*35=1  
364\*300\*35=2(M4\*40=8)  
Stove guard



500\*35\*70=1  
19 Door handle



450\*30\*50=1  
(M6\*70=2)  
20 Door handle



1860\*3400\*1=1(M11\*11=24)  
21 Rain cover



\*2  
22 Hole metal cover



\*6  
23 Spacer



\*6  
24 Nut



\*6  
25 Plastic cover

26

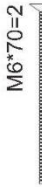

M6\*70=2  
Stainless steel screw for handle

27

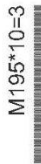

M195\*10=3  
Shaft

28



M3\*50=28  
Stainless steel Nail

29



M11\*11=24  
Pushpin

30

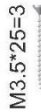

M3.5\*25=3  
Stainless steel screw

31

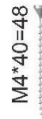

M4\*40=48  
Stainless steel screw

32



M4\*50=28  
Stainless steel screw

33



Screw driver for handle

34



Leveler

35



Mallet for adjust stave, not for screw

36



Bucket

37



spoon









38



Sandglass

**\*The above assembly diagram is for a quick reference visual guide only. All sauna models may not be shown. Parts and accessories do vary and are subject to change.**

## GDI-B004-01 (SJ-8241) – cont'd

ITEM#	IMAGE	PARTS LIST FOR GDI-B004-01 (SJ-8241)
1		<b>M3*50=28pcs</b> The 9th stave in every other stave through 21th stave: 14pcs
2		<b>M11*10=30pcs</b> Rain cover:30pcs
3		<b>M3*25=4pcs</b> Sandglass: 2pcs Thermometer:2pcs
4		Stove guard: 8pcs Bench wood back plank:10pcs Bench support wood:6 pcs front wall panel: 12pcs rear wall panel: 6pcs
5		Hex screw driver=1pc For bolts
6		Bench: 8pcs Backrest:8pcs Bench front wood plank: 4pcs The first stave: 2pcs The 7th stave on the right and left: 6pcs
7		<b>M6*70=2pcs</b> Door handle: 2pcs
8		Stainless steel screw-wide teeth for bands: 3pcs

\*The above assembly diagram is for a quick reference visual guide only. All sauna models may not be shown. Parts and accessories do vary and are subject to change.

# Components GDI-B006-01 (SJ-8341)

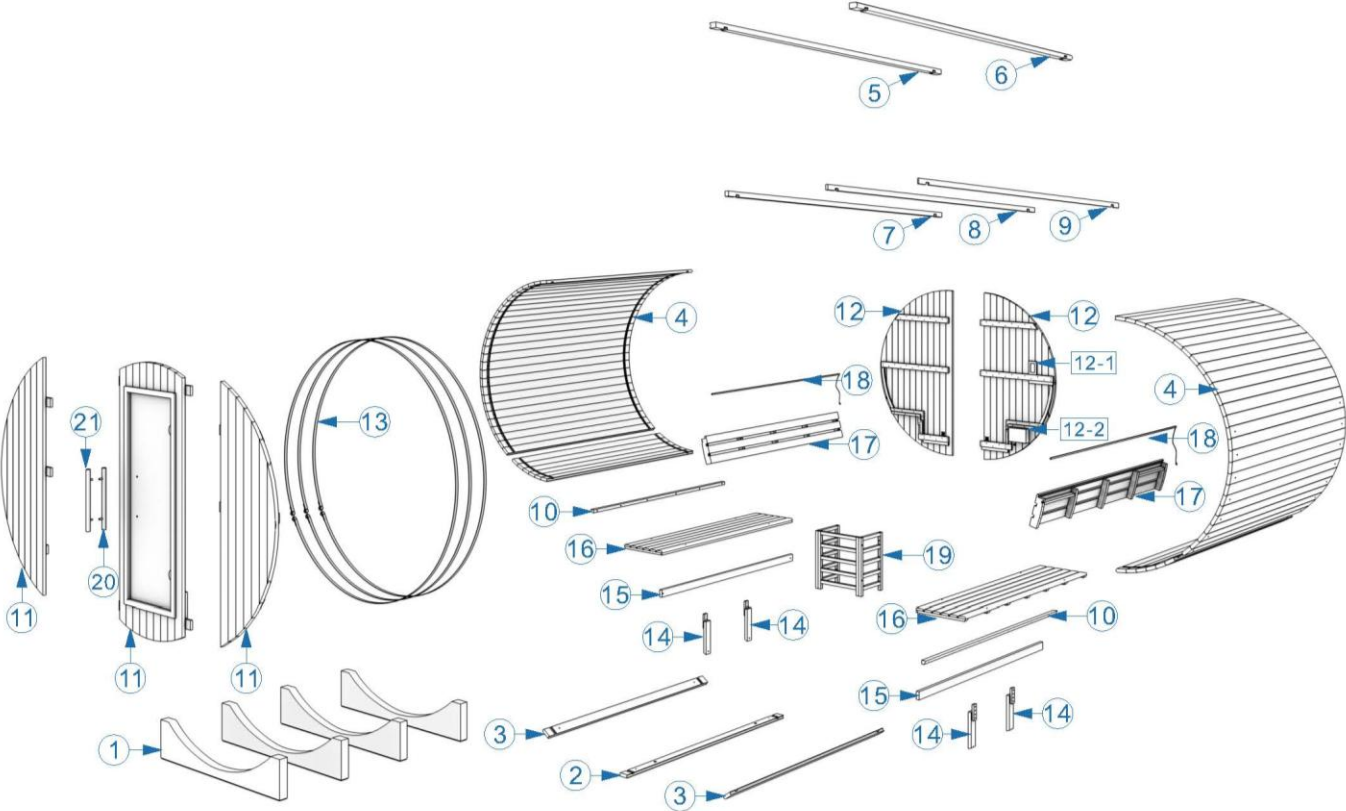

**\*The above assembly diagram is for a quick reference visual guide only. All sauna models may not be shown. Parts and accessories do vary and are subject to change.**

# GDI-B006-01 (SJ-8341) – cont'd

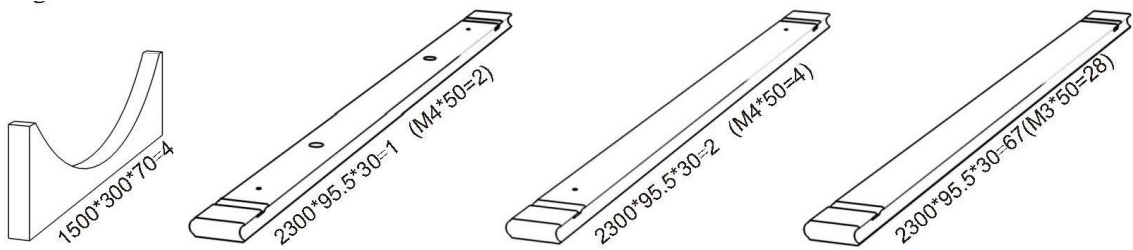

1 Cradles

2 The First bottom Stave  
(with two drain holes  
and 2 pre-drilled holes)

3 The 7th bottom staves  
(with 2 pre-drilled  
holes)

4 Standard staves

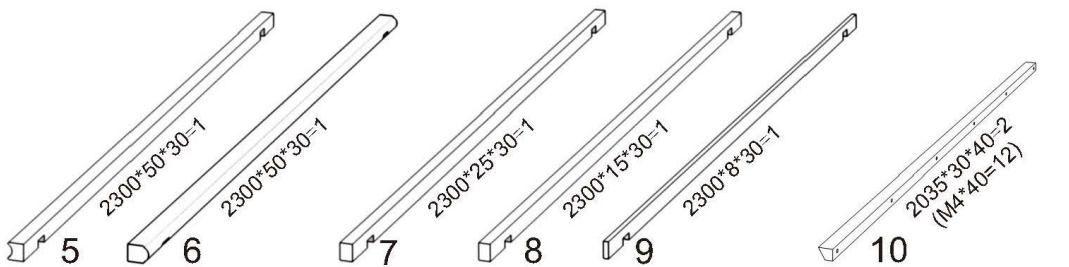

2 pcs top filling staves  
(Width: 50mm; 50mm)

3 pcs top filling staves  
(Width: 25mm; 15mm; 8mm)

Bench back wood plank

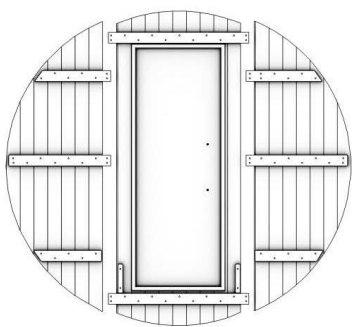

11 2006\*791+104\*30+20=1 (M4\*40=8)  
1850.2\*615.5+52.2\*30+20=2 (M4\*40=8)  
Front wall panel

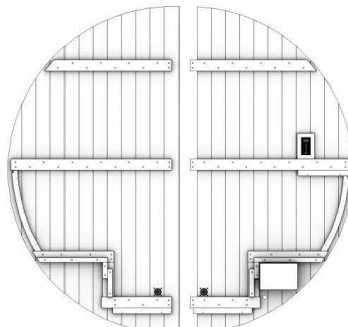

12 2006\*1054.5\*30+40=1  
2004.1\*959.5+42.9\*30+40  
(M4\*40=6)  
Rear wall panel

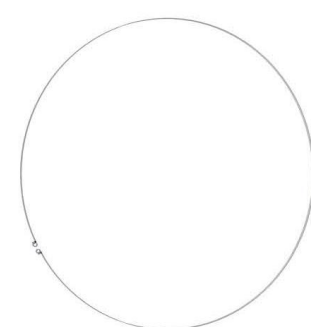

13 6352\*24\*0.5=3 (M195\*10=3)  
Stainless steel band

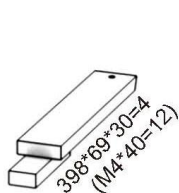

14 Bench support wood



15 Bench front wood plank

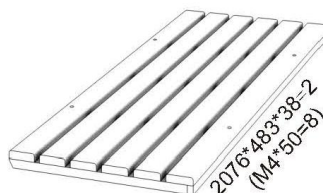

16 Bench

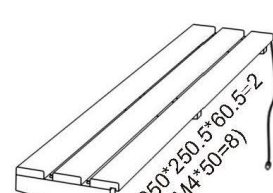



17 Backrest with Accent Light

**\*The above assembly diagram is for a quick reference visual guide only. All sauna models may not be shown. Parts and accessories do vary and are subject to change.**

# GDI-B006-01 (SJ-8341) – cont'd

- 

554\*300\*35=1  
364\*300\*35=2(M4\*40=8)  
**18** Stove guard
- 

500\*35\*70=1  
**19** Door handle
- 

450\*30\*50=1  
(M6\*70=2)  
**20** Door handle
- 

2330\*3400\*1=1(M11\*11=24)  
**21** Rain cover

- 

\*2  
**22** Hole metal cover
- 

\*6  
**23** Spacer
- 

\*6  
**24** Nut
- 

\*6  
**25** Plastic cover

- 26**



M6\*70=2  
Stainless steel screw for handle
- 27**



M195\*10=3  
Shaft
- 28**



M3\*50=28  
Stainless steel Nail
- 29**



M11\*11=24  
Pushpin
- 30**

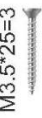

M3.5\*25=3  
Stainless steel screw
- 31**



M4\*40=54  
Stainless steel screw
- 32**



M4\*50=26  
Stainless steel screw

- 33**



Screw driver for handle
- 34**



Leveler
- 35**



Mallet for adjust stave, not for screw

- 36**



Bucket
- 37**











spoon
- 38**



Sandglass

**\*The above assembly diagram is for a quick reference visual guide only. All sauna models may not be shown. Parts and accessories do vary and are subject to change.**

## GDI-B006-01 (SJ-8341) – cont'd

ITEM#	IMAGE	PARTS LIST FOR GDI-B006-01 (SJ-8341)
1		<b>M3*50=28pcs</b> The 9th stave in every other stave through 21th stave: 14pcs
2		<b>M11*10=30pcs</b> Rain cover:30pcs
3		<b>M3*25=4pcs</b> Sandglass: 2pcs Thermometer:2pcs
4		Stove guard: 8pcs Bench wood back plank:12pcs Bench support wood:12pcs front wall panel: 12pcs rear wall panel: 6pcs
5		Hex screw driver=1pc For bolts
6		Bench: 8pcs Backrest:8pcs Bench front wood plank: 4pcs The first stave: 2pcs The 7th stave on the right and left: 6pcs
7		<b>M6*70=2pcs</b> Door handle: 2pcs
8		Stainless steel screw-wide teeth for bands: 3pcs

\*The above assembly diagram is for a quick reference visual guide only. All sauna models may not be shown. Parts and accessories do vary and are subject to change.

Each Barrel Sauna will need between 66-68 staves plus 1 set of the staves (narrow) for assembly. You will end up with some extra staves (wide) and some extra staves (narrow). The rain cover is an optional accessory.



**Stave (wide)**



**Stave (narrow set)**

## **What's Needed:**

**3 Adults**

**Claw Hammer**

**Ladder**

**Rope (optional)**

**Phillips Screwdriver (battery operated recommended)**

**17MM Wrench**

**Sandpaper and 1/4" drill bit (optional)**

## Basic Dimensions

GDI-B002-01 (SJ-8141)

2-Person Model

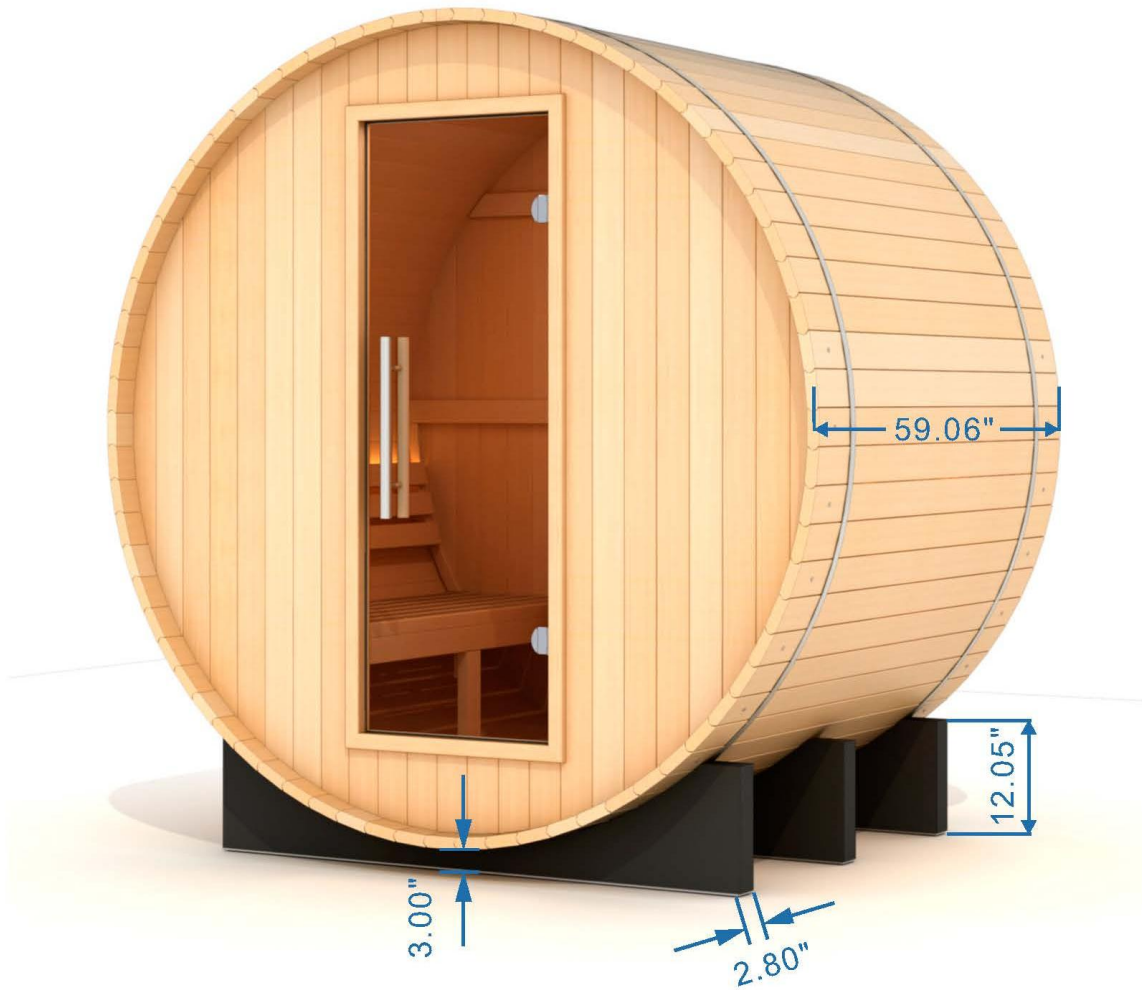

**\*THE PICTURES AND DIAGRAMS SHOWN WITHIN THIS OWNER'S MANUAL ARE REPRESENTATIONS OF THIS MODEL. ACTUAL MODEL MAY VARY. DESIGN AND CONSTRUCTION ARE SUBJECT TO CHANGE. BACKRESTS NOT INCLUDED.**

**GDI-B002-01 (SJ-8141)**

**2-Person Model - cont'd**

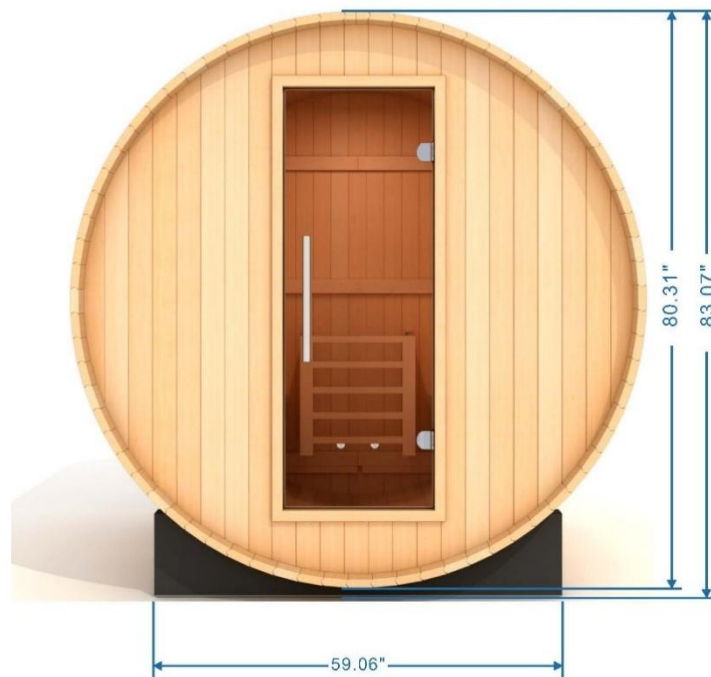
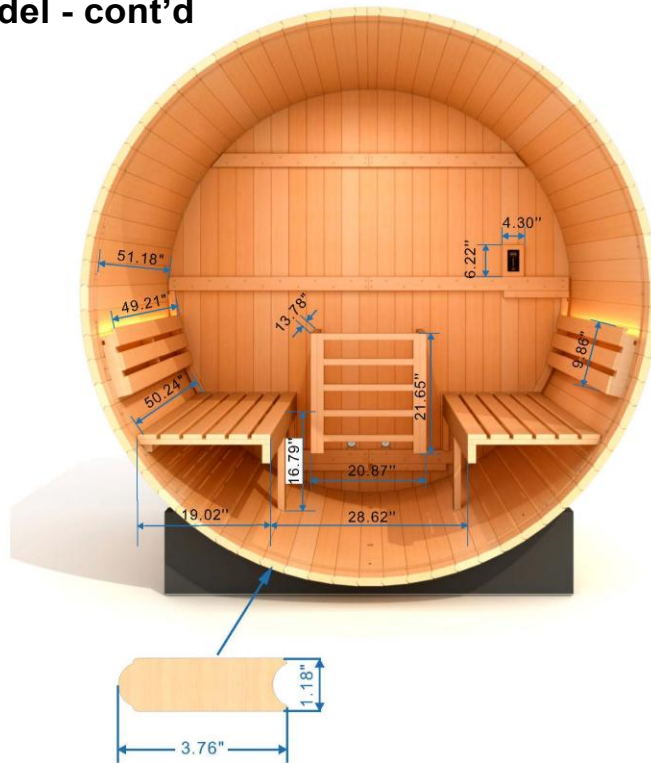

**\*THE PICTURES AND DIAGRAMS SHOWN WITHIN THIS OWNER'S MANUAL ARE REPRESENTATIONS OF THIS MODEL. ACTUAL MODEL MAY VARY. DESIGN AND CONSTRUCTION ARE SUBJECT TO CHANGE. BACKRESTS NOT INCLUDED.**

**GDI-B002-01 (SJ-8141)**  
**2-Person Model - cont'd**

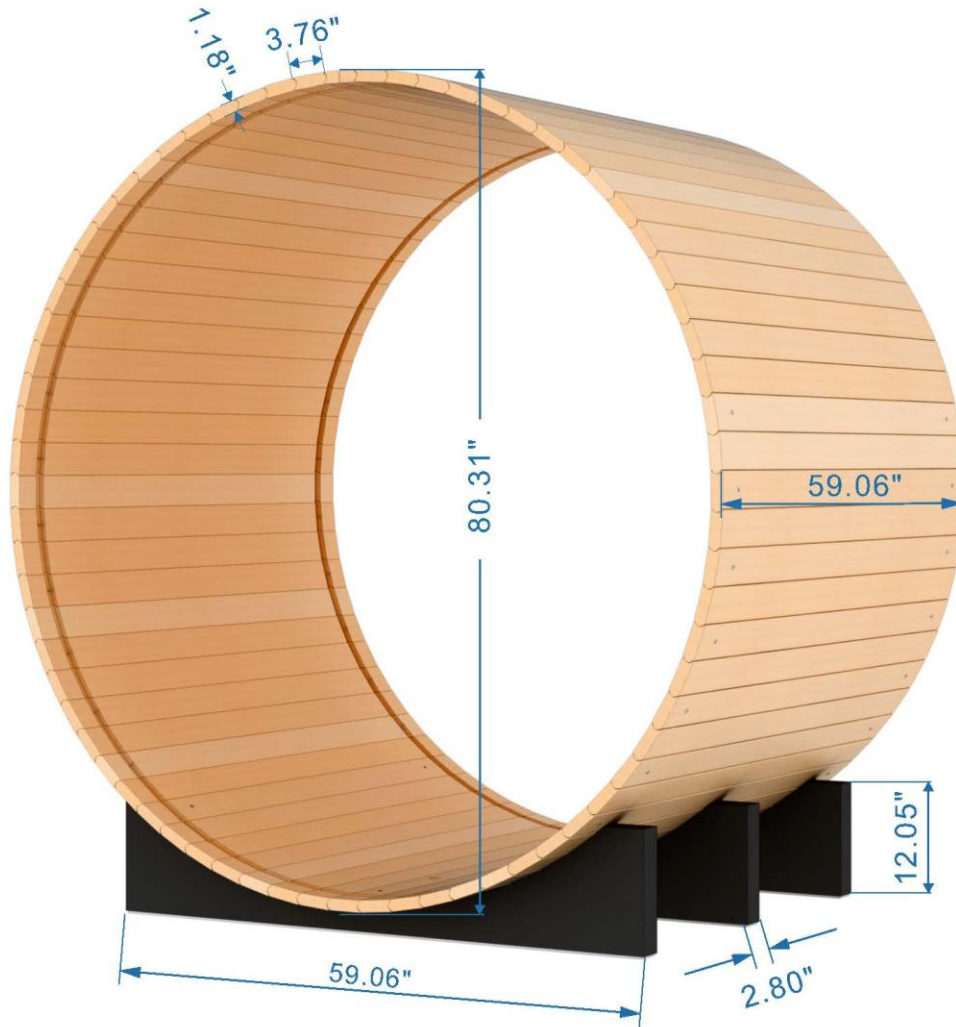

**\*THE PICTURES AND DIAGRAMS SHOWN WITHIN THIS OWNER'S MANUAL ARE REPRESENTATIONS OF THIS MODEL. ACTUAL MODEL MAY VARY. DESIGN AND CONSTRUCTION ARE SUBJECT TO CHANGE. BACKRESTS NOT INCLUDED.**

## Basic Dimensions

GDI-B004-01 (SJ-8241)

4-Person Model

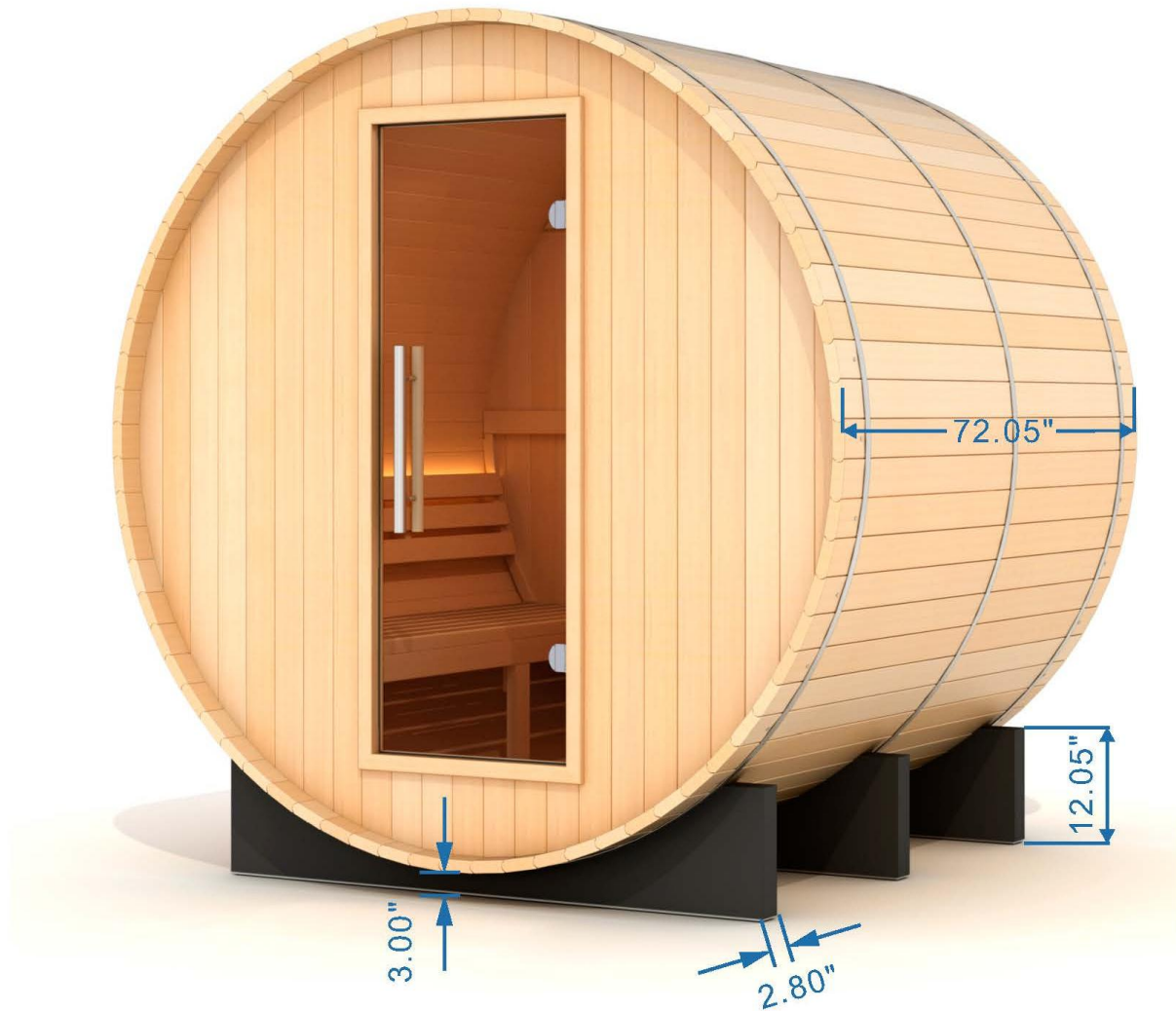

**\*THE PICTURES AND DIAGRAMS SHOWN WITHIN THIS OWNER'S MANUAL ARE REPRESENTATIONS OF THIS MODEL. ACTUAL MODEL MAY VARY. DESIGN AND CONSTRUCTION ARE SUBJECT TO CHANGE. BACKRESTS NOT INCLUDED.**

**GDI-B004-01 (SJ-8241)**  
**4-Person Model - cont'd**

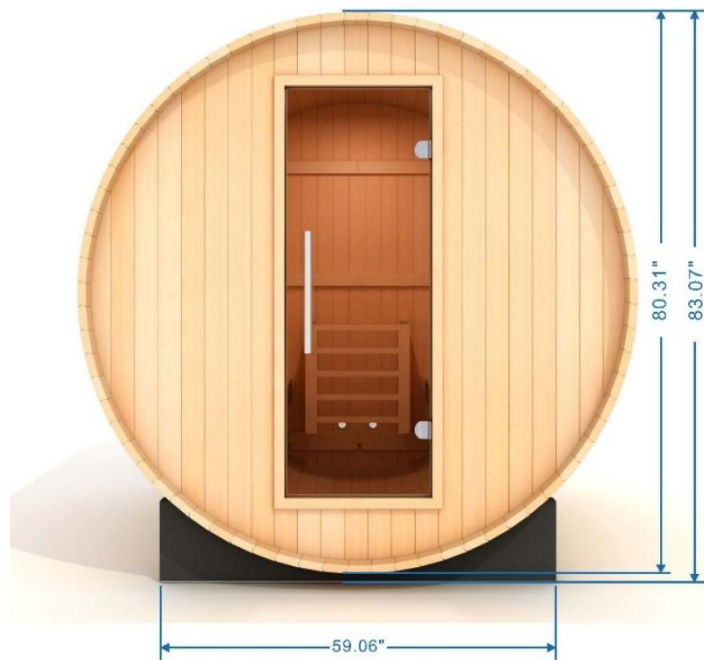
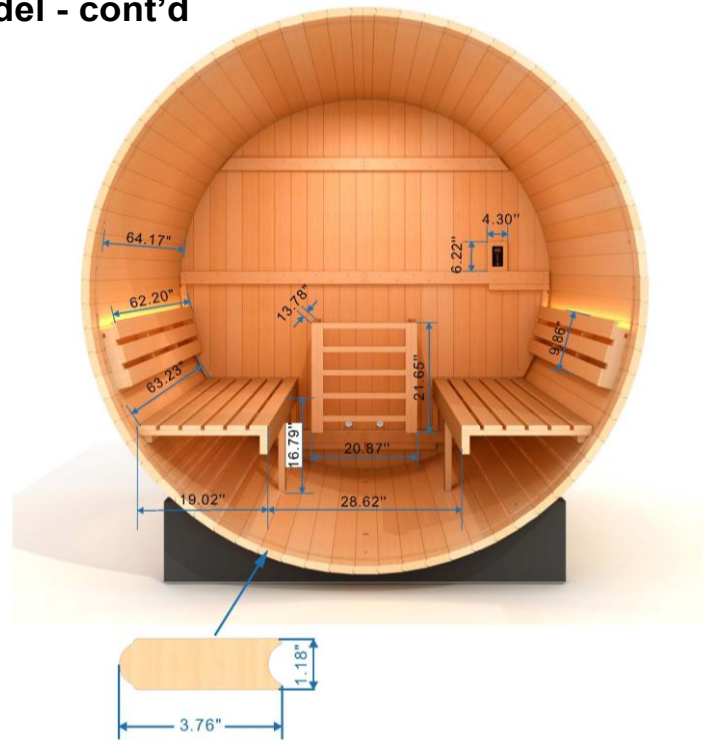

**\*THE PICTURES AND DIAGRAMS SHOWN WITHIN THIS OWNER'S MANUAL ARE REPRESENTATIONS OF THIS MODEL. ACTUAL MODEL MAY VARY. DESIGN AND CONSTRUCTION ARE SUBJECT TO CHANGE. BACKRESTS NOT INCLUDED.**

**GDI-B004-01 (SJ-8241)**  
**4-Person Model - cont'd**

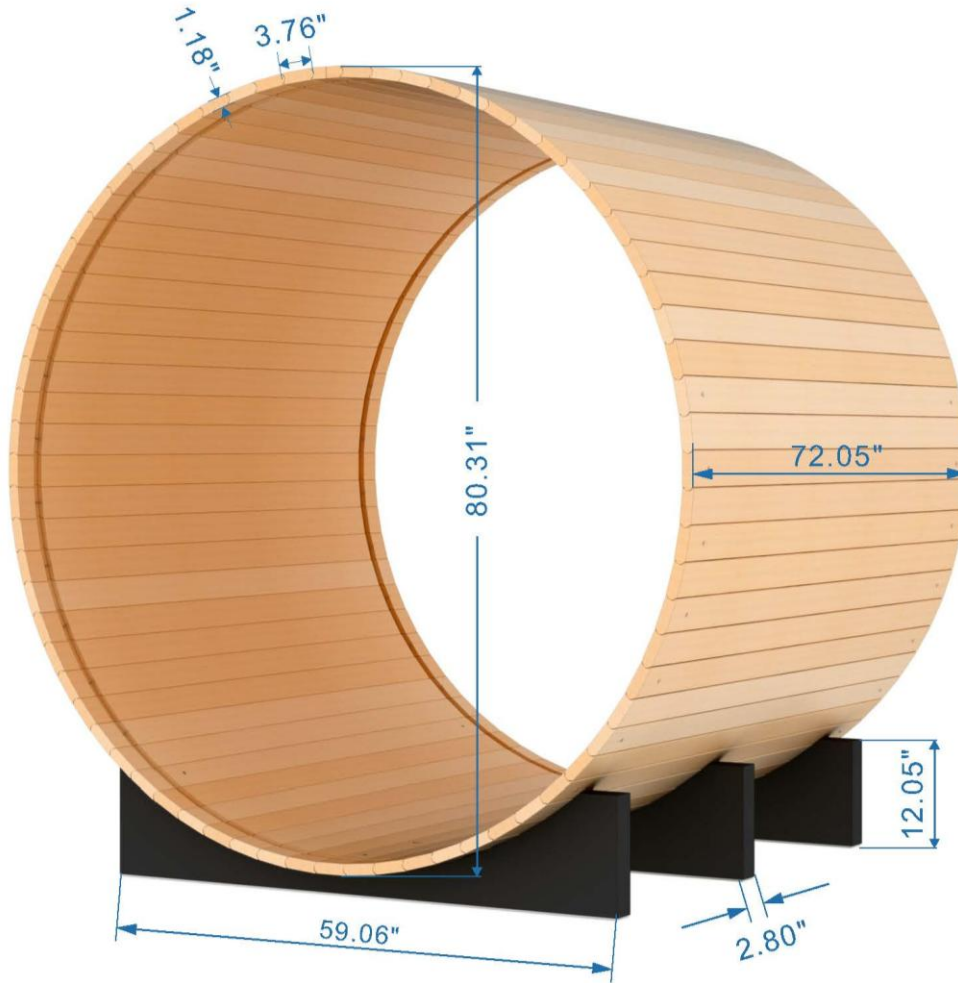

**\*THE PICTURES AND DIAGRAMS SHOWN WITHIN THIS OWNER'S MANUAL ARE REPRESENTATIONS OF THIS MODEL. ACTUAL MODEL MAY VARY. DESIGN AND CONSTRUCTION ARE SUBJECT TO CHANGE. BACKRESTS NOT INCLUDED.**

## Basic Dimensions

GDI-B006-01 (SJ-8341)

6-Person Model

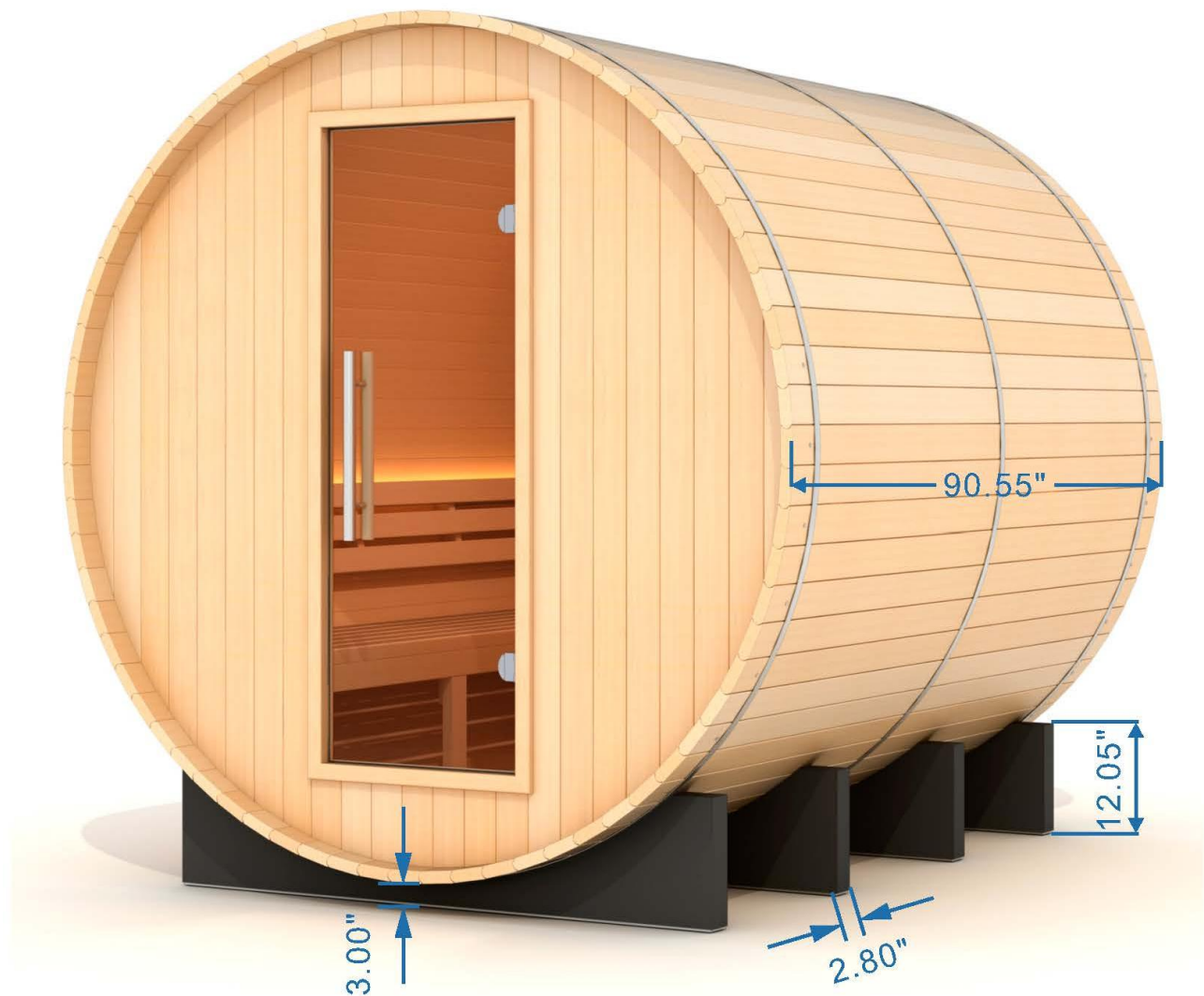

**\*THE PICTURES AND DIAGRAMS SHOWN WITHIN THIS OWNER'S MANUAL ARE REPRESENTATIONS OF THIS MODEL. ACTUAL MODEL MAY VARY. DESIGN AND CONSTRUCTION ARE SUBJECT TO CHANGE. BACKRESTS NOT INCLUDED.**

**GDI-B006-01 (SJ-8341)**  
**6-Person Model - cont'd**

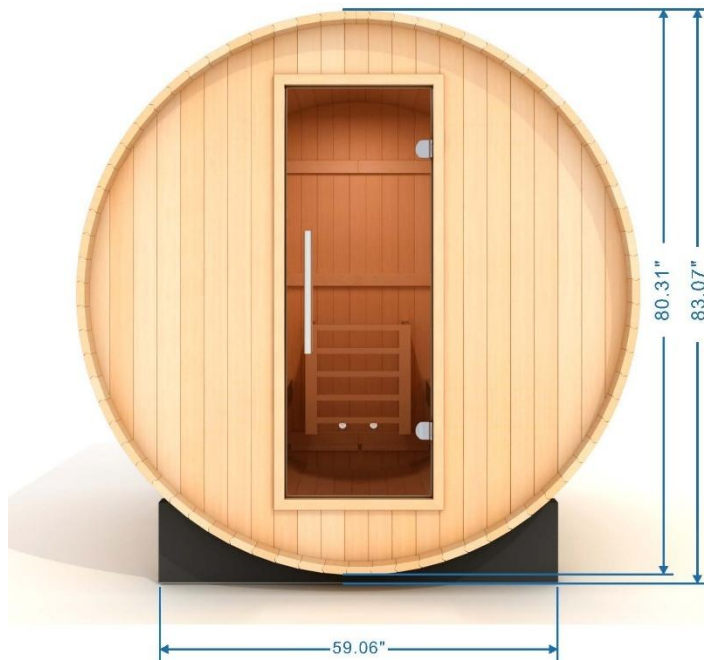
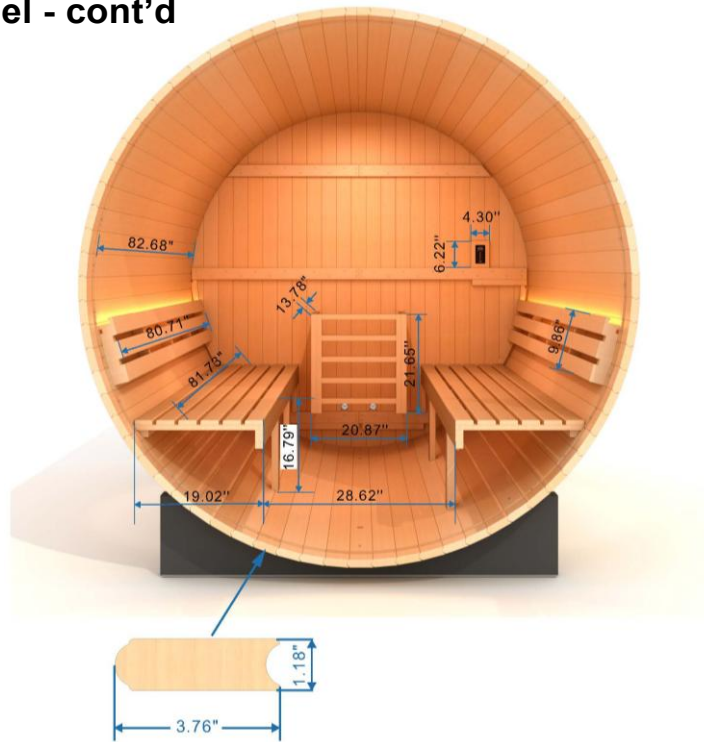

**\*THE PICTURES AND DIAGRAMS SHOWN WITHIN THIS OWNER'S MANUAL ARE REPRESENTATIONS OF THIS MODEL. ACTUAL MODEL MAY VARY. DESIGN AND CONSTRUCTION ARE SUBJECT TO CHANGE. BACKRESTS NOT INCLUDED.**

**GDI-B006-01 (SJ-8341)**  
**6-Person Model - cont'd**

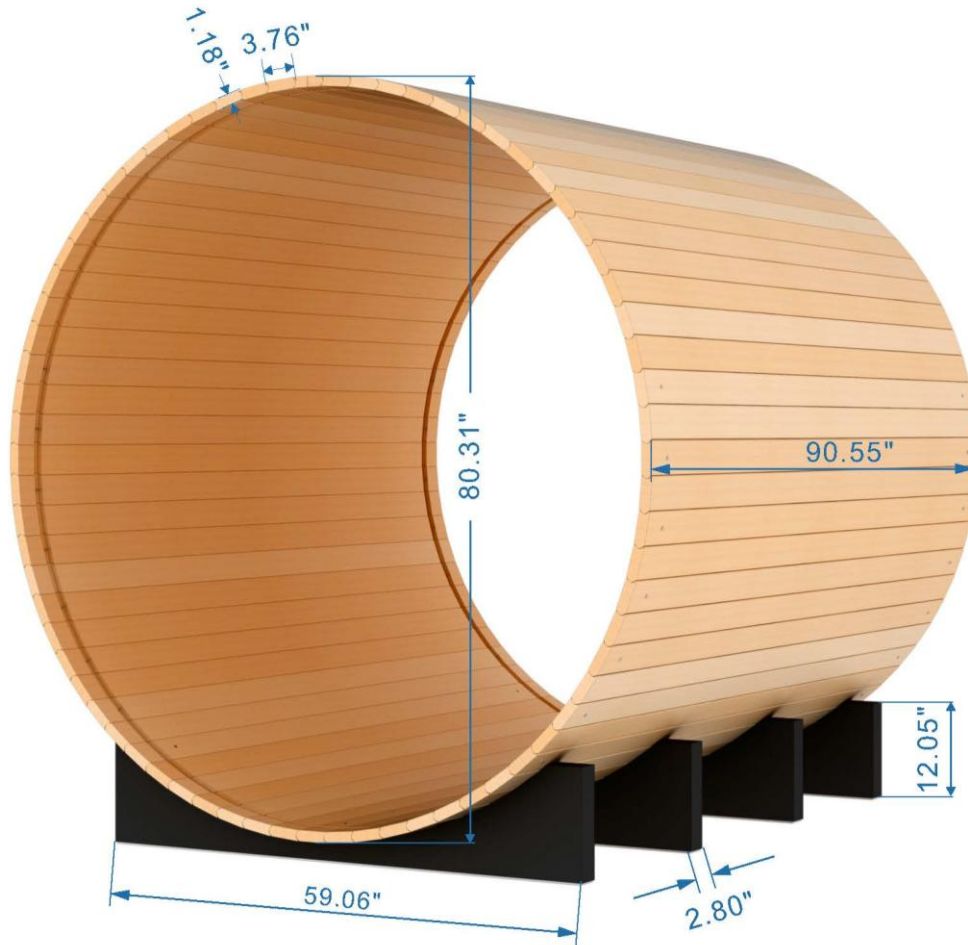

**\*THE PICTURES AND DIAGRAMS SHOWN WITHIN THIS OWNER'S MANUAL ARE REPRESENTATIONS OF THIS MODEL. ACTUAL MODEL MAY VARY. DESIGN AND CONSTRUCTION ARE SUBJECT TO CHANGE. BACKRESTS NOT INCLUDED.**

# Assembly Instructions

## 1. Place Bottom Support Cradles

Place the bottom support cradles at their desired locations. See figure 1. Determine the front and rear positions of the support cradle according to the marks on the floor. The 2-person model will have (3) support cradles. The 4-person model will have (3) support cradles. The 6-person model will have (4) support cradles. See figure 1a. To avoid damaging your floor, it is not recommended to move the sauna once it is assembled. If the unit is moved, please do so carefully and cautiously.

- a. Make sure there is a power outlet within reach of the power cord before assembling the barrel sauna. The light will require a 120V/15AMP outlet.
- b. Make sure to position the front door in the correct direction.

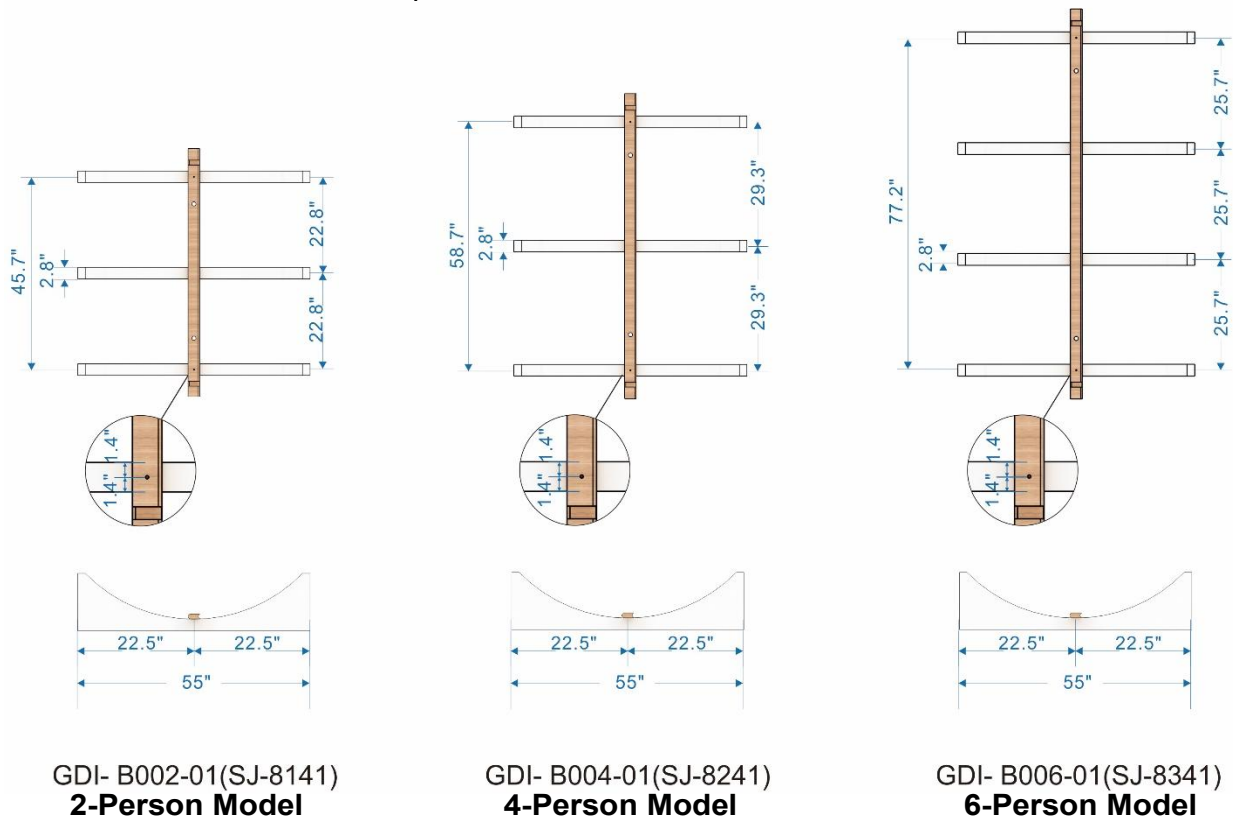

figure 1

## 2. Fix Bottom Support Cradles

Locate the two end staves with pre-drilled holes for the installation of the first stave. The first stave will have the drain holes. Place the first of the three staves (the one with the drain holes) on top of the support cradles. The end support cradles will have a sticker indicating where the first stave will screw to the cradle. Once the stave is placed into position onto the support cradles, you can use the provided two M4\*50 stainless steel screws to mount the stave to the support cradles. See the Components Section on page 5-6 for screw descriptions. Put the other two staves with the pre-drilled holes aside for now. See figure 2 & 2a.



figure 2

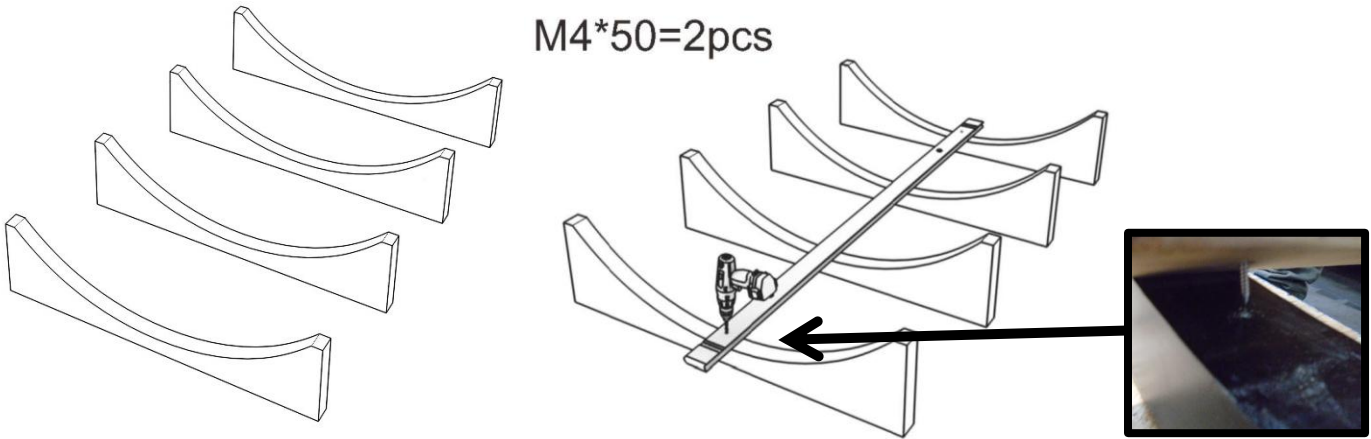

figure 2a

### 3. Place Staves On Support Cradles

Align the two ends of the staves. Carefully and accurately place them into the clamping staves. Use the leveler to make sure that each stave is placed level and straight. Do not allow excessive gaps in between the staves. See figure 3.

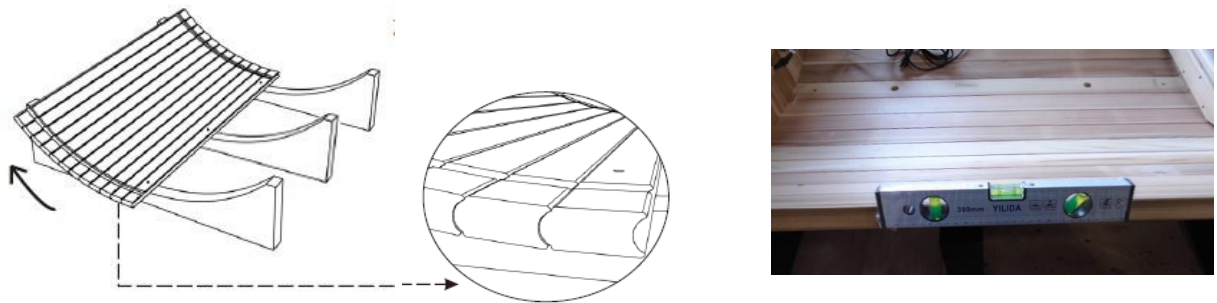

figure 3

### 4. Place Bottom Support Cradles

According to step 3, arrange the staves on the left side in sequence. Do the same with the right side. Again, make sure that each stave is level by using the leveler and rubber mallet. Keep the staves snug and tight. The two staves with the **pre-drilled**

holes will be the 7<sup>th</sup> staves (not counting the first installed staff) on the right and left. These two staves will need to be screwed down to the support cradles. Use the provided Allen Wrench to screw the M4\*50 to mount these staves to the support cradles. Do not use nails/screws on any staves you just installed except for the first staff. See figure 4.

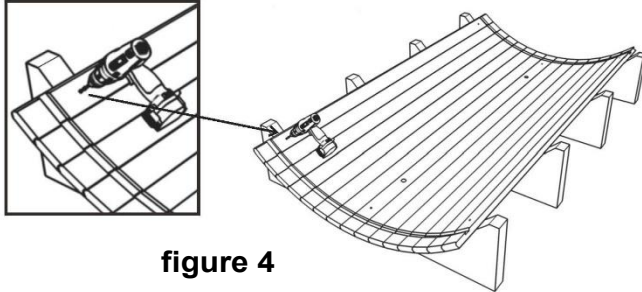

figure 4

GDI-B002-01 has 6 Stainless Steel Screws  
 GDI-B004-01 has 6 Stainless Steel Screws  
 GDI-B006-01 has 8 Stainless Steel Screws

**5. Place Rear Panel Onto Platform**

A. First, locate the two pieces that make up the rear wall panel. Use the provided screws to attach the two rear wall pieces together. Make sure the two sections are flush at the top and bottom. You will also need to connect the connection for the lights. See figure 5a & 5b.

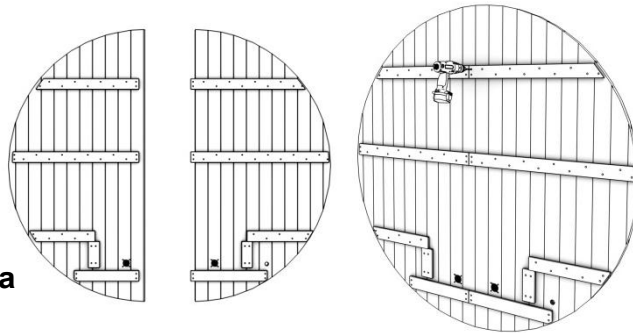

figure 5a

M4\*40  
 6 Stainless Steel Screws



Connection for Lights

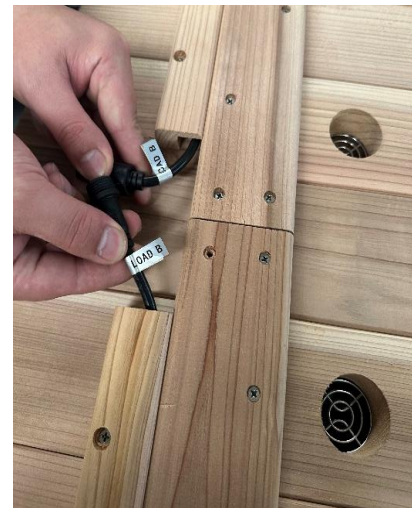

figure 5b

- B. Two people will need to lift the rear panel up and into the groove on the staves. Make sure the rear wall is positioned at where the rear of the barrel sauna will be and align the slots to accept the rear panel placement. One person will need to hold the rear panel in place to prevent it from falling. Use the leveler to position the rear panel vertically and horizontally straight. See figure 5c.



figure 5c

Adjust rear panel to be level.

Rear panel must fit into

## 6. Place Front Panel

- A. First, locate the three pieces that make up the front wall panel. Use the provided screws to attach the three front wall pieces together. Make sure that three sections are flush at the top and bottom. See figure 6a.

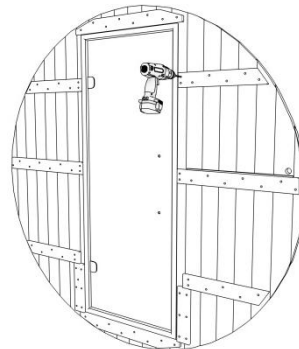
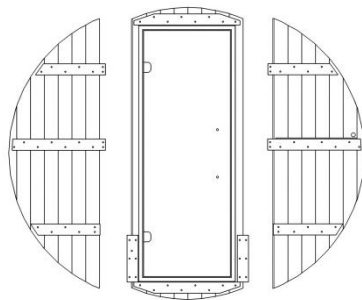

**M4\*40**  
12 Stainless Steel Screws

figure 6a

- B. Two people will need to lift the front panel up and into the groove on the staves. Make sure the front wall is positioned at where the front of the barrel sauna will be and align the slots to accept the front panel placement. Make sure that the front panel is in the correct position and right side up. You will find the horizontal wood beams on the interior side of the front wall. One person will need to hold the front panel in place to prevent it from falling. Use the leveler to position the front panel vertically and horizontally straight. See figure 6b.



figure 6b



Adjust front panel to be level.



Front panel must fit into

## 7. After Placing Front Panel Onto Platform

You can use one of the staves to hold the front and the rear panels in place. Make sure the groove on each end of the stave fits onto the front and rear to hold them stationary in place. This is a temporary step to hold the front and rear panels in place. **You can use a stave to also help to hold the front panel and rear panel in place. One adult will need to continue to hold the front panel in place. Do not nail/screw this stave down.** See figure 7.

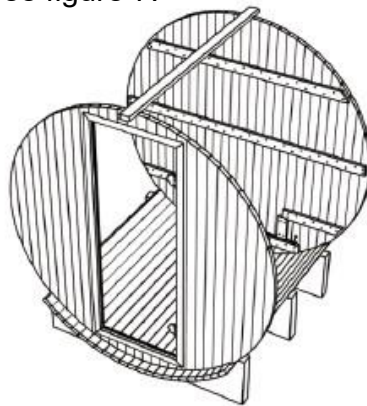

figure 7

## 8. Install the Staves

Continue to install and align the two ends of the staves onto the front and rear working your way upward. Carefully and accurately place them onto the front and rear. Use the leveler and mallet to make sure that each stave is placed level and straight. Do not allow excessive gaps in between the staves. Attach the stave using the provided stainless steel nails from the exterior starting from the 9<sup>th</sup> stave (not counting the first installed stave) in **every other** stave through the 21<sup>st</sup> stave. **From the 21<sup>st</sup> stave, do not nail in any additional staves.** The nails are used to mount and keep the staves aligned and straight. Be sure to use a hammer (not the included mallet) when hammering the stainless steel nails. See figure 8.

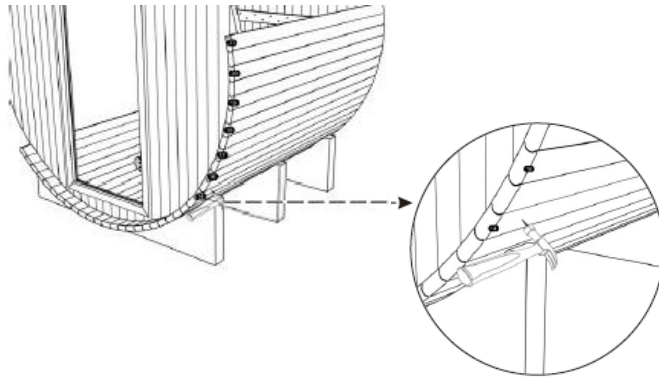

figure 8

Attach at every other stave.

## 9. Install Staves

After reaching the 21<sup>th</sup> stave on the right side (when standing and facing the front door of the barrel sauna), you can stop on the right side and continue to install the staves from the left side until you have almost reached the right side. **From the 21<sup>st</sup> stave, be sure not to nail in any additional staves.** If necessary (optional), you may use a rope or strap to tie around the barrel while placing the remaining staves in place so that they do not fall out. Do not nail in any nails into these staves that will fit next to the stave pieces (**these are the various thinner/skinny staves**). You will want to leave space to install the thinner staves which you received in five pieces. Carefully fit the pieces into the left over space being very careful not to break the thinner stave pieces. You do not need to use all five pieces. See figure 9.

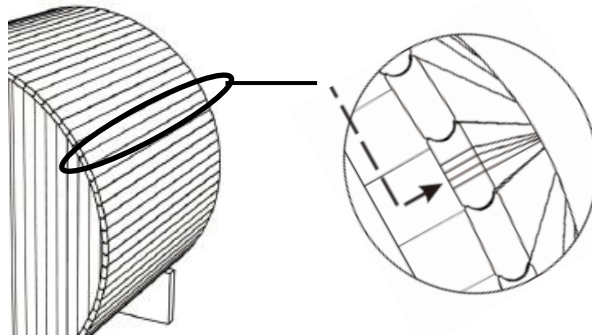

figure 9

The last stave is cut into several pieces to fit into the last space.

## 10. Install Stainless Steel Bands

Use the stainless steel bands to fasten the barrel sauna together. You will align the outer stainless steel bands with the inside of the front and rear support cradles. Use a 17MM wrench to tighten the bolts on the stainless steel bands. You may need to wrenches to

tighten. Be sure not to over tighten. In addition, you will need to check the tightness of the stainless steel bands every 6-12 months. See figure 10.

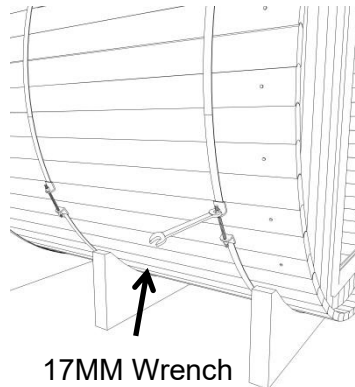
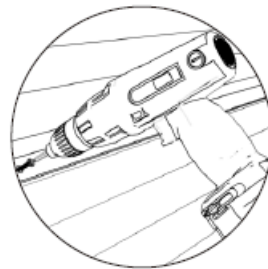
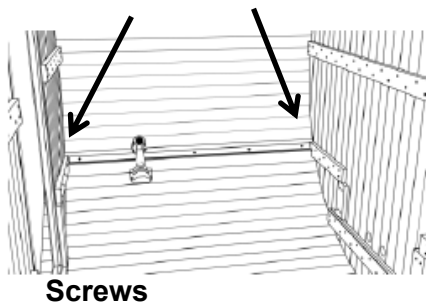

**figure 10** Attention: The joint position of the stainless steel band should be near the top and to the inside of the support cradles.

**Be sure to inspect the tightness of the stainless steel bands every 4-6 months to minimize small gaps. If the stainless steel bands become loose, use the 17mm wrench to tighten.**

### 11. Install Bench Supports

Start with the left side. Use a Phillips screwdriver (power screwdriver will save time) to screw the five pieces of M4\*40 screws into the lower bench back wood plank in order to mount to the wall. The back wood plank needs to be level with the wood planks on the front and rear panels. Use a leveler to make sure the lower bench back wood plank is horizontally straight before screwing into place. See figure 11 & 11a. Do the same for the right side.



**figure 11**



figure 11a

## 12. Install Bench Front Wood Plank and Front Bench Lower Reinforcement

Start with the left side. Install the front wood plank as seen in figure 12 and figure 12a. You can start with either the right or left side first. The bench support wood consists of two pieces for GDI-B002-01, two pieces for GDI-B004-01, and four pieces for GDI-B006-01. The bench support wood will mount vertically. For GDI-B002-01/GDI-B004-01, each bench support will need to be centered on each bench front wood plank. For GDI-B006-01, two bench supports will need to be installed per figure 12a onto the bench front wood plank. Use the two screws to mount each bench support wood vertically to the bench front wood plank. Do the same for the opposite side.

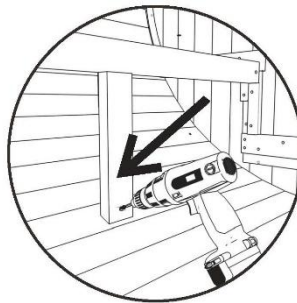
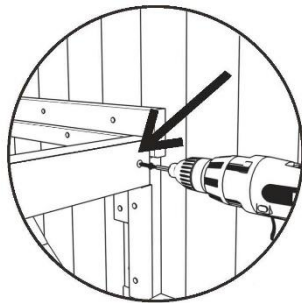

Bench Support Wood

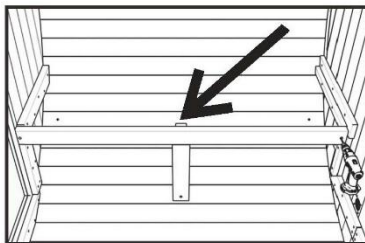
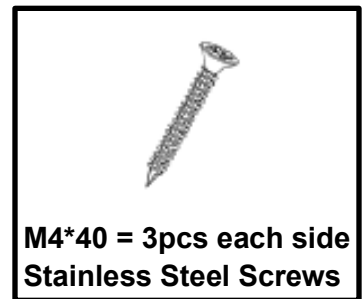

Bench Front Wood Plank



figure 12

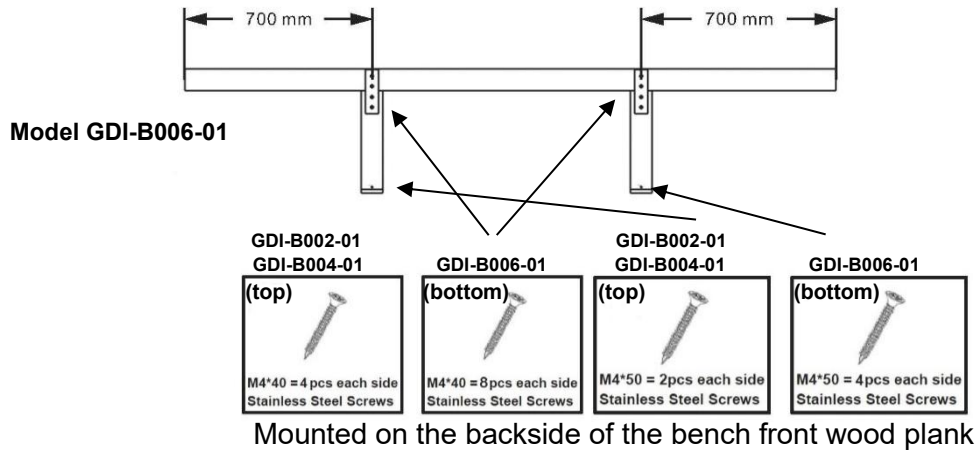

**figure 12a**

### 13. Install Bench Panel

Start with the left side. Place the bench panel into position over the horizontal beam. Use the two/four screws (depending on model) to mount the bench into place. See figure 13. Do the same for the right side.



**figure 13**

### 14. Install Backrest

Start with the left side. Place the backrest into position using the leveler to make sure that it is level. The bottom of the backrest will sit above the bench. Use the (2) screws to mount the backrest into place. You will need to connect the connection for the lights. See figure 14 & 14a. Follow the same steps for the right side. The power cord can be ran through the rear wall panel to be connected to a 120V/ 15AMP outlet.



**figure 14**



figure 14a

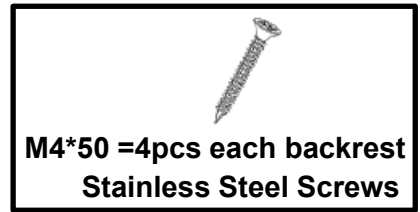

M4\*50 =4pcs each backrest  
Stainless Steel Screws

2 screws for  
left side of  
each backrest  
and 2 screws  
for right side  
of each  
backrest

### 15. Install Stove and Stove Guard

The stove must be installed by a certified electrician per the manufacturer's manual. Follow all of the stove's manufacturer's instructions when installing the stove. **Please note that the certified electrician will need to drill a hole in the wall for the power cord.** Assemble the stove wood guard as seen in figure 15. Figures 15a-15c shows where the wood mounts for the stove need to be installed. Once the stove wood mounts are installed, the stove wood guard will need to be mounted to the inside of the front panel. The stove wood guard will serve as protection around the stove.

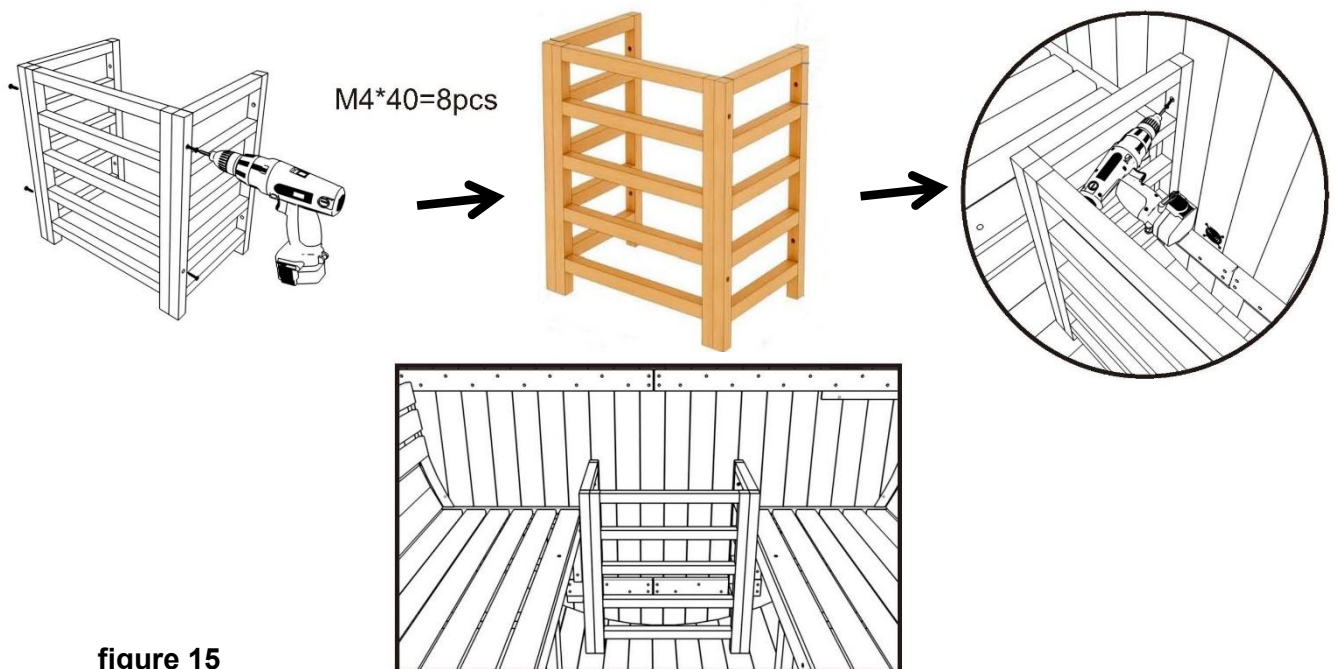

figure 15

## 16. Install Door Handle

Install the door handle to the glass door. Use the two screws to screw one side of the door handle to the other side with the glass door in between. See figure 16.

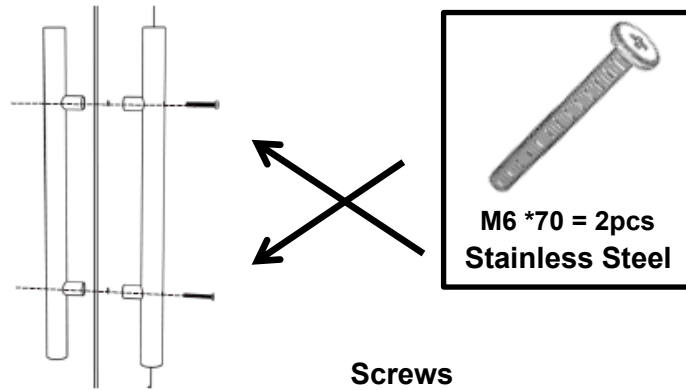

figure 16

## 17. Install Roof Rain Cover (Optional)

You have the option of installing the barrel sauna under a covered structure or out in the open. If you install the barrel sauna under a covered structure where it will not be affected by the weather elements, then it is optional to install the rain cover. If the barrel sauna is installed in an open area leaving it exposed to the weather elements, then you may experience some moisture seeping into the cabin. This will not hurt the cabin or stove. But if you wish to not experience this, you may want to install the rain cover.

To install the rain cover, locate the rain cover. Spread the rain cover over the top of the barrel sauna. The rain cover should droop about two thirds downward on the barrel sauna. Be sure to pull the rain cover tightly around the perimeter of the barrel sauna making sure it is smooth and flat. Next and toward the edges, fold the edges of the rain cover and use the provided (7) rain cover pushpins for each side to secure the rain cover at the front and rear of the sauna barrel. The remaining (8) rain cover pushpins are to be used to secure the horizontal edges for each side. See figure 23.



figure 23

## 18. Installing the Optional Accessories

You have the option of purchasing the additional accessories including the drink shelf, magazine rack, robe hook, head rest (discontinued), and leg rest (discontinued). Use the provided screws to install the accessories as seen below in figure 24. It is recommended to drill a  $\frac{1}{4}$ " pilot hole to prevent cracking the wood.

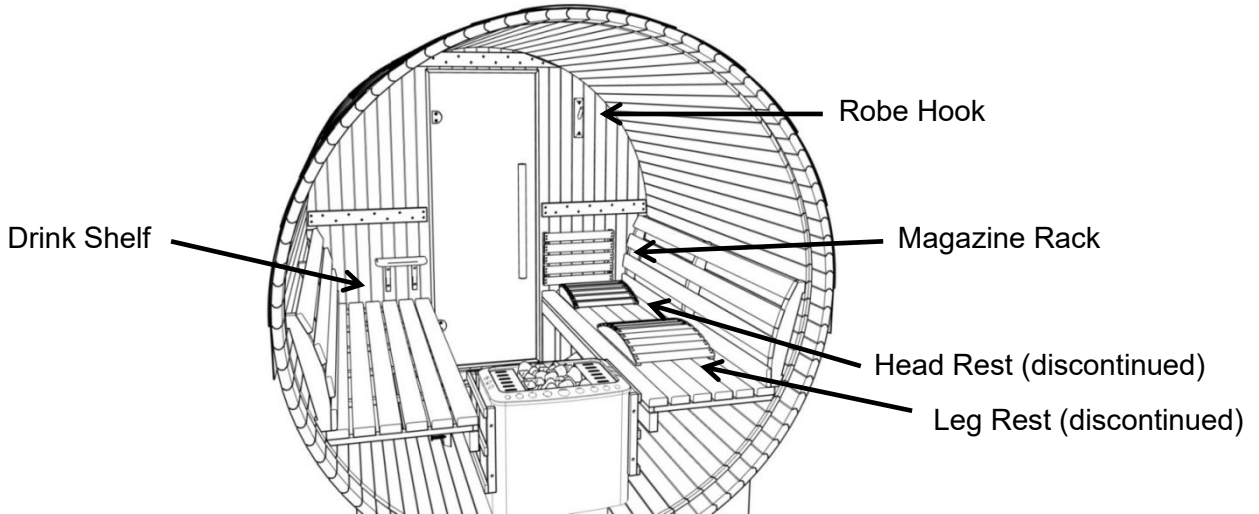
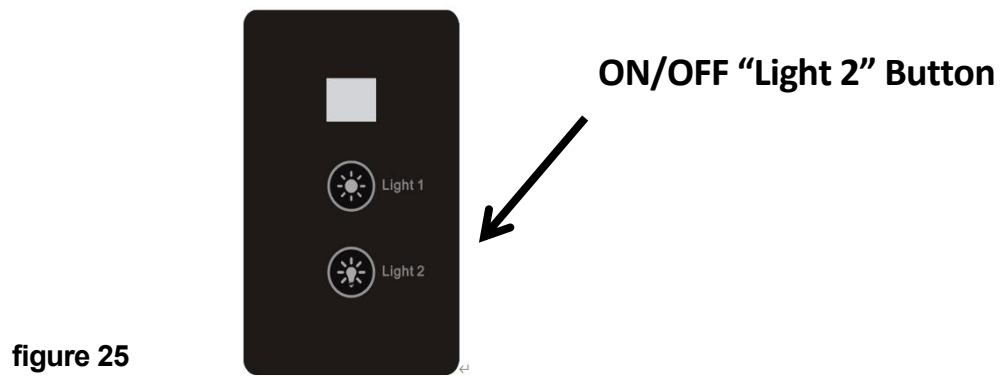

figure 24

**Assembly Complete**

## Using the Barrel Sauna

1. When entering the sauna, you can turn ON the light by pressing the “Light 2” button. **Please note that the “Light 1” button has no function on this model barrel sauna.** See figure 25.
2. Set the stove to the desired temperature, usually between 150°F - 180°F. If you are a beginner, then you would want to start at the lower temperature and gradually work your way up. Follow all stove instructions for stove usage.
3. It is best to remove all clothing before taking a sauna. Swimsuits can be worn if need be. It is recommend not to wear eyeglasses, contact lenses, jewelry, etc.
4. The sauna session can be 5 minutes to 15 minutes. **Make sure to stay hydrated with plenty of water.**
5. Cool down for about 10 minutes to 20 minutes before showing.



## Tips for using Your Sauna

- 1) If you take a hot/warm shower or bath before using your sauna, you may perspire more and experience more comfort.
- 2) Drink water prior to, during, and after your sauna session to replenish body fluids.
- 3) The ventilation vent is installed on the sauna and should never be obstructed.
- 4) You can use 2 towels during your sauna session. Fold one of the towels several times and place it on the bench. This towel will absorb some of your perspiration while adding comfort as you sit on the bench. Use a second towel to wipe perspiration from your body from time to time.
- 5) This is a non-commercial sauna. For every four hours ON, the sauna must be turned OFF for one hour to cool down.

- 6) At the first sign of a cold or flu, increasing your sauna sessions may be beneficial in boosting your immune system and decreasing the reproductive rate of viruses.
- 7) To help relieve sore and tense muscles, massage the affected areas during your sauna session.
- 8) The peaceful and relaxed state rendered by a sauna session may help you to sleep easier and deeper.
- 9) To protect the user from coming into contact with the heater, be sure to install the heater wood guard.
- 10) After the sauna session is over, do not jump into the shower or bath immediately. Because your body was heated up during the sauna session, it will continue to perspire even after you exit the sauna room. Sit in the sauna with the door open slightly and let your body cool down. Once your body has cooled down and you feel comfortable, you can exit the sauna. After about twenty minutes and when your body has completely cooled down, you can take a shower to rinse the perspiration off your body.
- 11) To avoid a hazard, do clean the sauna floor of all perspiration and debris after each sauna session.

## Safety Instructions

- 1.) Read and follow all instructions carefully before using the sauna.
- 2.) When installing and using the electrical equipment, safety precautions should always be followed.
- 3.) To reduce the risk of injury, do not allow children to use the sauna unless they are directed by a medical doctor and are closely supervised at all times by an adult.
- 4.) Do not use the sauna immediately following strenuous exercises. Wait at least 30 minutes to allow the body to cool down completely.
- 5.) Pregnant or possibly pregnant women should contact their physician prior to using the sauna. Excessive temperature has a high potential for causing fetal damage during pregnancy.
- 6.) **Hyperthermia Danger:** the normal body temperature can't rise above 39°C (103°F). Symptoms of excessive hyperthermia include dizziness, lethargy, drowsiness, and fainting. The effects of excessive hyperthermia may include failure to perceive heat, physical inability to exit sauna, unawareness of impending hazard, unconsciousness and fetal damage in pregnant women. Hyperthermia could make your body's core temperature rise. Setting desired temperature to an excessively high temperature is not recommended.

- 7.) The use of alcohol, drugs, or medications prior to or during the sauna session may lead to unconsciousness and/or other harmful physical injuries.
- 8.) Persons suffering from obesity or with a medical history of heart disease, low or high blood pressure, circulatory system problems, or diabetes should consult a physician prior to using the sauna.
- 9.) Persons using medications should consult a physician before using the sauna. Some medications may induce drowsiness while others may affect the heart rate, blood pressure, and/or blood circulation.
- 10) Exercise care before and after sauna use.
- 11) Never sleep inside the sauna.
- 12) Do not use any type of cleaning agents on the interior of the sauna. Only wipe down with a cloth and water.
- 13) Do not stack or store any object on top or inside the sauna.
- 14) If the heater cord becomes damaged, it must be replaced immediately by a certified electrician. If you find the power cord is too hot or that the electrical equipment may be experiencing technical problems, please contact the manufacturer of the heater or its agent immediately to avoid hazardous conditions.
- 15) Do not use the sauna during an electrical storm to avoid risk of shock.
- 16) Do not touch the glass door hinges during sauna use as they become very hot to the touch.
- 17) Your hands must be dry and free of moisture before plugging and unplugging cords and wiring harnesses. Never operate the sauna with wet hands or wet feet to avoid risk of electric shock. Never touch the metal prongs of the plug.
- 18) Do not attempt to make any repairs yourself without contacting the manufacturer first. If a problem occurs with the sauna, please contact seller, distributor, or the manufacturer to avoid safety risks. Unauthorized repair attempts will void the manufacturer's warranty.
- 19) Please make sure the supplied power meets the specifications required. Failure to meet the requirements may cause safety risks.
- 20) Do not attempt to touch any electrical parts or make repairs on your own when using the sauna.
- 21) Do not bump, hit, or break the heater as it may cause an electrical short and pose a safety risk.
- 22) Do not make any modifications to the sauna, the sauna structure, or the sauna components.
- 23) Prior to each sauna session, the sauna room is to be inspected for correct

operation. If for any reason your sauna room does not seem to be operating properly, discontinue use and contact the manufacturer.

## Safeguards For Your Sauna

1. Do not install the sauna near an open water source.
2. Do not use liquid cleaners or aerosol cleansers inside the sauna. Make sure the power source is off before cleaning. Use plain water and a soft cloth for cleaning.
3. The power cord should be routed so that it is not walked on or pinched by any object that may be placed against it.
4. When replacement parts are required, be sure they meet the specified requirements of the manufacturer. Unauthorized substitutes may result in fire, electric shock, or other hazardous conditions. After any repairs, please ask the service technician to perform safety checks to determine that your sauna is working properly.
5. Do not use any wall receptacle adapter or extension cords. The heater must be hardwired by a certified electrician. Make sure the electrical cord is not crushed or pinched.
6. For sauna rooms with exterior wood finishes, you will need to maintain the exterior finish. **Never use stain on the interior of the sauna as it must remain all natural.** Consult the stain manufacturer for any off-gassing concerns. Please note that the cedar wood does start turning grey after approximately 1 – 2 years if the wood is not maintained with a UV protectant. Depending on the severity of the weather elements in your area, you will want to apply an exterior wood water repellent treatment within a month of assembly and 2-3 times per year from there on.
7. To clean the interior, you can vacuum and sweep down the floors. Use water and a non-toxic cleaner with a damp cloth to wipe down the entire sauna including the benches and walls. For cleaning the heater and stones, please refer to the manufacturer's instructions. Improper use or placement of stones within the heater can result in improper performance of the heater and hazardous conditions. Please note that the heater must be OFF and covered when cleaning the interior of the sauna so not to damage any of the components of the heater, especially if you hose down the interior of the barrel sauna.
8. Check the stainless steel bands from time-to-time as they may need to be tightened due to the wood swelling and contracting.

# Troubleshooting

## Glass Door Adjustment

1. To adjust the glass door, you will need two people and a few sheets of cardboard. One person will be on the outside of the glass door and the other person on the inside. The person on the inside will need the applicable sized Allen wrench to loosen the screws (a few turns only) on the glass door while the door is slightly opened. Next, the person on the outside of the glass door will push the glass door shut with the cardboard sheets placed vertically and horizontally between the glass door and door jamb. See the images below. Once the glass door is shut completely, the person on the inside will need to tighten the screws. Be sure the screws are tight so the glass door does not slip out of alignment again. Then you can open the door and remove the cardboard sheets. The glass door should now open and close properly.



Loosen the screws slightly



Cardboard placed vertically & horizontally between glass door and door jamb

2. For any troubleshooting issues with the stove, please contact the stove manufacturer directly.

## Limited Lifetime Warranty

**\*Limited Lifetime Warranty:** Golden Designs, Inc. warrants the sauna room against defects in material and workmanship for the life of the product from the original date of purchase. **The sauna is for indoor use or outdoor use depending on the model. When placed outdoors, a water proof cover or the sauna shingle roof may be installed to cover the sauna room for protection. Any damage due to direct exposure to outdoor weather elements such as rain, snow, sun, wind or extreme temperatures will not be covered by this warranty if your sauna was not designed to be directly in the weather elements. Any damages as a result of modifications made to the sauna or its components will void this warranty.**

**Extent of Warranty:** This limited warranty applies to products manufactured or distributed by Golden Designs, Inc. under the Golden Designs Inc. brand name, delivered in the contiguous United States or Canada and extends to the original purchaser at the original site of installation only. This warranty becomes valid at time of purchase and terminates either by specified time frame, owner transfer, or relocation. The warranty extends to the sauna room and excludes the heater as it is covered by its own manufacturer warranty. **Your sales receipt showing the date of purchase of the product is your proof of purchase.**

### Manufacturer Warranty

All Golden Designs, Inc. products are manufactured with the highest quality and are warranted to be free from defects in material and workmanship at the time of delivery. The warranty is extended through the manufacturer for the product including, but not limited to: sauna room, sauna control panel, and the connected wire harnesses. All exchanged parts and products replaced under this warranty will become the property of Golden Designs, Inc. Golden Designs, Inc. reserves the right to change for any part not covered under the existing warranty. Any parts determined to be defective must be returned to Golden Designs, Inc. at its discretion to obtain warranty service. You must prepay any shipping charges, export taxes, custom duties and taxes, or any other charges associated with the transportation of the parts. In addition, you are responsible for insuring any parts shipped or returned. You must present Golden Designs, Inc. with proof of purchase documents (including the date of purchase). Any evidence of alteration, erasing or forgery of proof of purchase documents will be cause to **VOID** this limited warranty. Products on which the serial number has been defaced or removed is not eligible for warranty service. The product warranty covers parts, but does not cover labor.

### Warranty Limitations

This warranty does not apply if the unit has been subject to full commercial use, negligence, alteration, modification, misuse, abuse, repairs by non-Golden Designs, Inc. authorized personnel, inappropriate installations, or any case beyond the control of Golden Designs, Inc. invalidating this warranty including but are not limited to:

- Improper use of lacquer or paints
- Sauna and other Golden Designs, Inc. products accessories placed on non-approved surfaces
- Outdoor applications not protected safely from outdoor weather elements, including the glass door

- Normal wear and tear or weathering
- Use of product not in accordance with instructions
- Improper use of the sauna
- Moisture or water seepage

**Surface cracks are not considered defects in material or workmanship, as they are normal characteristics of all woods. This includes minor cracks due to wood expansion and contraction. Since the wood used in construction may have been kiln dried, a certain amount of expansion and contraction occurs in the wood in a sauna environment. Please note that water seepage will not hurt the wood and is a normal tendency of outdoor application. The water will usually dry quickly due to the heated environment. If you want to keep the sauna completely dry, you will need to install the barrel sauna under a covered structure.**

### **Disclaimers**

Golden Designs, Inc. shall not be liable for loss of use of sauna or other Golden Designs, Inc. products or other secondary or incidental or consequential costs, expense or damages - which may include the removal of permanent structures or other custom fixtures or the necessity for crane removal - arising directly or indirectly out of the use or inability to use the product. Any implied warranty shall have duration equal of the applicable warranty stated above. Under no circumstances shall Golden Designs, Inc. or any of its representatives be held liable for injury to any person or damage to any property, however arising. Specifications are subject to change without notice or obligation.

### **Legal Remedies**

This limited warranty gives you specific legal rights. You may have other rights, which may vary from state to state.

### **Customer Service**

For customer service, contact your authorized dealer. If you need additional information or assistance, please email Golden Designs, Inc. at [info@goldendesignsinc.com](mailto:info@goldendesignsinc.com) or call (909) 212-5555.

**\*Limited Lifetime Warranty of Sauna Products is 5 years on wood structure (when properly maintained), control panel, and applicable control panel harnesses and lights from the date of purchase. Stove/heater is covered under its manufacturer's applicable warranty.**

## WARRANTY REGISTRATION

Congratulations on your purchase of an Infrared Sauna from Golden Designs, Inc. Please take the time to register your warranty using the QR Code:



If you do not have the QR Code Reader, you can also register at:

<https://app.goldendesigninc.com/public/RegisteredProduct>

Please include a copy of your sales receipt or packing slip when registering. The serial number (S/N) is located on the sauna's front panel, rear panel, or on the carton.

**The warranty must be registered within 60 days of the purchase date.**